

# R&S<sup>®</sup> ETL TV Analyzer First Steps



2112.0079.62 – 11

The First Steps manual describes the following R&S<sup>®</sup>ETL model:

- 2112.0004.13

The firmware of the instrument makes use of several valuable open source software packages. The most important of them are listed below, together with their corresponding open source license. The verbatim license texts are provided in the release notes.

Package	Link	License
OpenSSL	<a href="http://www.openssl.org">http://www.openssl.org</a>	OpenSSL/SSLeavy
zlib	<a href="http://www.zlib.net">http://www.zlib.net</a>	zlib, v.1.2.3
Xalan Xerces	<a href="http://xalan.apache.org/">http://xalan.apache.org/</a> <a href="http://xerces.apache.org/">http://xerces.apache.org/</a>	Apache Software License, Version 2.0
ONC/RPC	<a href="http://www.plt.rwth-aachen.de">http://www.plt.rwth-aachen.de</a>	SUN
VLC	<a href="http://www.videolan.org/">http://www.videolan.org/</a>	GPL V2

Rohde & Schwarz would like to thank the open source community for their valuable contribution to embedded computing.

U.S. Patent Nos. 4,631,603; 4,819,098; 4,907,093; 5,315,448; 6,381,747; and 6,516,132.  
used for the Video and Audio Hardware Decoder option (R&S ETL-B281).

© 2007 - 2012 Rohde & Schwarz GmbH & Co. KG  
Muehldorfstr. 15, 81671 Munich, Germany  
Phone: +49 89 41 29 - 0  
Fax: +49 89 41 29 12 164  
E-mail: [info@rohde-schwarz.com](mailto:info@rohde-schwarz.com)  
Internet: <http://www.rohde-schwarz.com>

Printed in Germany – Subject to change – Data without tolerance limits is not binding.  
R&S<sup>®</sup> is a registered trademark of Rohde & Schwarz GmbH & Co. KG.  
Trade names are trademarks of the owners.

The following abbreviations are used throughout this manual:  
R&S<sup>®</sup>XYZ is abbreviated as R&S XYZ.

# Basic Safety Instructions

## **Always read through and comply with the following safety instructions!**

All plants and locations of the Rohde & Schwarz group of companies make every effort to keep the safety standards of our products up to date and to offer our customers the highest possible degree of safety. Our products and the auxiliary equipment they require are designed, built and tested in accordance with the safety standards that apply in each case. Compliance with these standards is continuously monitored by our quality assurance system. The product described here has been designed, built and tested in accordance with the attached EC Certificate of Conformity and has left the manufacturer's plant in a condition fully complying with safety standards. To maintain this condition and to ensure safe operation, you must observe all instructions and warnings provided in this manual. If you have any questions regarding these safety instructions, the Rohde & Schwarz group of companies will be happy to answer them.

Furthermore, it is your responsibility to use the product in an appropriate manner. This product is designed for use solely in industrial and laboratory environments or, if expressly permitted, also in the field and must not be used in any way that may cause personal injury or property damage. You are responsible if the product is used for any purpose other than its designated purpose or in disregard of the manufacturer's instructions. The manufacturer shall assume no responsibility for such use of the product.













The product is used for its designated purpose if it is used in accordance with its product documentation and within its performance limits (see data sheet, documentation, the following safety instructions). Using the product requires technical skills and, in some cases, a basic knowledge of English. It is therefore essential that only skilled and specialized staff or thoroughly trained personnel with the required skills be allowed to use the product. If personal safety gear is required for using Rohde & Schwarz products, this will be indicated at the appropriate place in the product documentation. Keep the basic safety instructions and the product documentation in a safe place and pass them on to the subsequent users.

Observing the safety instructions will help prevent personal injury or damage of any kind caused by dangerous situations. Therefore, carefully read through and adhere to the following safety instructions before and when using the product. It is also absolutely essential to observe the additional safety instructions on personal safety, for example, that appear in relevant parts of the product documentation. In these safety instructions, the word "product" refers to all merchandise sold and distributed by the Rohde & Schwarz group of companies, including instruments,

## Basic Safety Instructions

systems and all accessories. For product-specific information, see the data sheet and the product documentation.

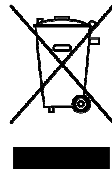



### Symbols and safety labels

Symbol	Meaning	Symbol	Meaning
	Notice, general danger location Observe product documentation	○	ON/OFF supply voltage
	Caution when handling heavy equipment	⏻	Standby indication
	Danger of electric shock	— — —	Direct current (DC)
	Warning! Hot surface	~	Alternating current (AC)
	Protective conductor terminal	⎓	Direct/alternating current (DC/AC)
	Ground		Device fully protected by double (reinforced) insulation
	Ground terminal		EU labeling for batteries and accumulators For additional information, see section "Waste disposal/Environmental protection", item 1.
	Be careful when handling electrostatic sensitive devices		EU labeling for separate collection of electrical and electronic devices For additional information, see section "Waste disposal/Environmental protection", item 2.
	Warning! Laser radiation For additional information, see section "Operation", item 7.		

## Basic Safety Instructions

### Signal words and their meaning

The following signal words are used in the product documentation in order to warn the reader about risks and dangers.

	Indicates an imminently hazardous situation which, if not avoided, will result in death or serious injury.
	Indicates a potentially hazardous situation which, if not avoided, could result in death or serious injury.
	Indicates a potentially hazardous situation which, if not avoided, could result in minor or moderate injury.
	Indicates the possibility of incorrect operation which can result in damage to the product. In the product documentation, the word ATTENTION is used synonymously.

These signal words are in accordance with the standard definition for civil applications in the European Economic Area. Definitions that deviate from the standard definition may also exist in other economic areas or military applications. It is therefore essential to make sure that the signal words described here are always used only in connection with the related product documentation and the related product. The use of signal words in connection with unrelated products or documentation can result in misinterpretation and in personal injury or material damage.

### Operating states and operating positions

*The product may be operated only under the operating conditions and in the positions specified by the manufacturer, without the product's ventilation being obstructed. If the manufacturer's specifications are not observed, this can result in electric shock, fire and/or serious personal injury or death. Applicable local or national safety regulations and rules for the prevention of accidents must be observed in all work performed.*

1. Unless otherwise specified, the following requirements apply to Rohde & Schwarz products:  
predefined operating position is always with the housing floor facing down, IP protection 2X, use only indoors, max. operating altitude 2000 m above sea level, max. transport altitude 4500 m above sea level. A tolerance of  $\pm 10\%$  shall apply to the nominal voltage and  $\pm 5\%$  to the nominal frequency, overvoltage category 2, pollution severity 2.

## Basic Safety Instructions

2. Do not place the product on surfaces, vehicles, cabinets or tables that for reasons of weight or stability are unsuitable for this purpose. Always follow the manufacturer's installation instructions when installing the product and fastening it to objects or structures (e.g. walls and shelves). An installation that is not carried out as described in the product documentation could result in personal injury or even death.
3. Do not place the product on heat-generating devices such as radiators or fan heaters. The ambient temperature must not exceed the maximum temperature specified in the product documentation or in the data sheet. Product overheating can cause electric shock, fire and/or serious personal injury or even death.

### Electrical safety

*If the information on electrical safety is not observed either at all or to the extent necessary, electric shock, fire and/or serious personal injury or death may occur.*

1. Prior to switching on the product, always ensure that the nominal voltage setting on the product matches the nominal voltage of the AC supply network. If a different voltage is to be set, the power fuse of the product may have to be changed accordingly.
2. In the case of products of safety class I with movable power cord and connector, operation is permitted only on sockets with a protective conductor contact and protective conductor.
3. Intentionally breaking the protective conductor either in the feed line or in the product itself is not permitted. Doing so can result in the danger of an electric shock from the product. If extension cords or connector strips are implemented, they must be checked on a regular basis to ensure that they are safe to use.
4. If there is no power switch for disconnecting the product from the AC supply network, or if the power switch is not suitable for this purpose, use the plug of the connecting cable to disconnect the product from the AC supply network. In such cases, always ensure that the power plug is easily reachable and accessible at all times. For example, if the power plug is the disconnecting device, the length of the connecting cable must not exceed 3 m. Functional or electronic switches are not suitable for providing disconnection from the AC supply network. If products without power switches are integrated into racks or systems, the disconnecting device must be provided at the system level.

## Basic Safety Instructions

5. Never use the product if the power cable is damaged. Check the power cables on a regular basis to ensure that they are in proper operating condition. By taking appropriate safety measures and carefully laying the power cable, ensure that the cable cannot be damaged and that no one can be hurt by, for example, tripping over the cable or suffering an electric shock.
6. The product may be operated only from TN/TT supply networks fuse-protected with max. 16 A (higher fuse only after consulting with the Rohde & Schwarz group of companies).
7. Do not insert the plug into sockets that are dusty or dirty. Insert the plug firmly and all the way into the socket provided for this purpose. Otherwise, sparks that result in fire and/or injuries may occur.
8. Do not overload any sockets, extension cords or connector strips; doing so can cause fire or electric shocks.
9. For measurements in circuits with voltages  $V_{\text{rms}} > 30 \text{ V}$ , suitable measures (e.g. appropriate measuring equipment, fuse protection, current limiting, electrical separation, insulation) should be taken to avoid any hazards.
10. Ensure that the connections with information technology equipment, e.g. PCs or other industrial computers, comply with the IEC60950-1/EN60950-1 or IEC61010-1/EN 61010-1 standards that apply in each case.
11. Unless expressly permitted, never remove the cover or any part of the housing while the product is in operation. Doing so will expose circuits and components and can lead to injuries, fire or damage to the product.
12. If a product is to be permanently installed, the connection between the protective conductor terminal on site and the product's protective conductor must be made first before any other connection is made. The product may be installed and connected only by a licensed electrician.
13. For permanently installed equipment without built-in fuses, circuit breakers or similar protective devices, the supply circuit must be fuse-protected in such a way that anyone who has access to the product, as well as the product itself, is adequately protected from injury or damage.
14. Use suitable overvoltage protection to ensure that no overvoltage (such as that caused by a bolt of lightning) can reach the product. Otherwise, the person operating the product will be exposed to the danger of an electric shock.
15. Any object that is not designed to be placed in the openings of the housing must not be used for this purpose. Doing so can cause short circuits inside the product and/or electric shocks, fire or injuries.

## Basic Safety Instructions

16. Unless specified otherwise, products are not liquid-proof (see also section "Operating states and operating positions", item 1). Therefore, the equipment must be protected against penetration by liquids. If the necessary precautions are not taken, the user may suffer electric shock or the product itself may be damaged, which can also lead to personal injury.
17. Never use the product under conditions in which condensation has formed or can form in or on the product, e.g. if the product has been moved from a cold to a warm environment. Penetration by water increases the risk of electric shock.
18. Prior to cleaning the product, disconnect it completely from the power supply (e.g. AC supply network or battery). Use a soft, non-linting cloth to clean the product. Never use chemical cleaning agents such as alcohol, acetone or diluents for cellulose lacquers.

## Operation

1. Operating the products requires special training and intense concentration. Make sure that persons who use the products are physically, mentally and emotionally fit enough to do so; otherwise, injuries or material damage may occur. It is the responsibility of the employer/operator to select suitable personnel for operating the products.
2. Before you move or transport the product, read and observe the section titled "Transport".
3. As with all industrially manufactured goods, the use of substances that induce an allergic reaction (allergens) such as nickel cannot be generally excluded. If you develop an allergic reaction (such as a skin rash, frequent sneezing, red eyes or respiratory difficulties) when using a Rohde & Schwarz product, consult a physician immediately to determine the cause and to prevent health problems or stress.
4. Before you start processing the product mechanically and/or thermally, or before you take it apart, be sure to read and pay special attention to the section titled "Waste disposal/Environmental protection", item 1.
5. Depending on the function, certain products such as RF radio equipment can produce an elevated level of electromagnetic radiation. Considering that unborn babies require increased protection, pregnant women must be protected by appropriate measures. Persons with pacemakers may also be exposed to risks from electromagnetic radiation. The employer/operator must evaluate workplaces where there is a special risk of exposure to radiation and, if necessary, take measures to avert the potential danger.



## Basic Safety Instructions

6. Should a fire occur, the product may release hazardous substances (gases, fluids, etc.) that can cause health problems. Therefore, suitable measures must be taken, e.g. protective masks and protective clothing must be worn.
7. Laser products are given warning labels that are standardized according to their laser class. Lasers can cause biological harm due to the properties of their radiation and due to their extremely concentrated electromagnetic power. If a laser product (e.g. a CD/DVD drive) is integrated into a Rohde & Schwarz product, absolutely no other settings or functions may be used as described in the product documentation. The objective is to prevent personal injury (e.g. due to laser beams).
8. EMC classes (in line with CISPR 11)  
Class A: Equipment suitable for use in all environments except residential environments and environments that are directly connected to a low-voltage supply network that supplies residential buildings.  
Class B: Equipment suitable for use in residential environments and environments that are directly connected to a low-voltage supply network that supplies residential buildings.

### Repair and service

1. The product may be opened only by authorized, specially trained personnel. Before any work is performed on the product or before the product is opened, it must be disconnected from the AC supply network. Otherwise, personnel will be exposed to the risk of an electric shock.
2. Adjustments, replacement of parts, maintenance and repair may be performed only by electrical experts authorized by Rohde & Schwarz. Only original parts may be used for replacing parts relevant to safety (e.g. power switches, power transformers, fuses). A safety test must always be performed after parts relevant to safety have been replaced (visual inspection, protective conductor test, insulation resistance measurement, leakage current measurement, functional test). This helps ensure the continued safety of the product.

### Batteries and rechargeable batteries/cells

*If the information regarding batteries and rechargeable batteries/cells is not observed either at all or to the extent necessary, product users may be exposed to the risk of explosions, fire and/or serious personal injury, and, in some cases, death. Batteries and rechargeable batteries with alkaline electrolytes (e.g. lithium cells) must be handled in accordance with the EN 62133 standard.*

## Basic Safety Instructions

1. Cells must not be taken apart or crushed.
2. Cells or batteries must not be exposed to heat or fire. Storage in direct sunlight must be avoided. Keep cells and batteries clean and dry. Clean soiled connectors using a dry, clean cloth.
3. Cells or batteries must not be short-circuited. Cells or batteries must not be stored in a box or in a drawer where they can short-circuit each other, or where they can be short-circuited by other conductive materials. Cells and batteries must not be removed from their original packaging until they are ready to be used.
4. Cells and batteries must not be exposed to any mechanical shocks that are stronger than permitted.
5. If a cell develops a leak, the fluid must not be allowed to come into contact with the skin or eyes. If contact occurs, wash the affected area with plenty of water and seek medical aid.
6. Improperly replacing or charging cells or batteries that contain alkaline electrolytes (e.g. lithium cells) can cause explosions. Replace cells or batteries only with the matching Rohde & Schwarz type (see parts list) in order to ensure the safety of the product.
7. Cells and batteries must be recycled and kept separate from residual waste. Rechargeable batteries and normal batteries that contain lead, mercury or cadmium are hazardous waste. Observe the national regulations regarding waste disposal and recycling.

## Transport

1. The product may be very heavy. Therefore, the product must be handled with care. In some cases, the user may require a suitable means of lifting or moving the product (e.g. with a lift-truck) to avoid back or other physical injuries.
2. Handles on the products are designed exclusively to enable personnel to transport the product. It is therefore not permissible to use handles to fasten the product to or on transport equipment such as cranes, fork lifts, wagons, etc. The user is responsible for securely fastening the products to or on the means of transport or lifting. Observe the safety regulations of the manufacturer of the means of transport or lifting. Noncompliance can result in personal injury or material damage.

## Basic Safety Instructions

3. If you use the product in a vehicle, it is the sole responsibility of the driver to drive the vehicle safely and properly. The manufacturer assumes no responsibility for accidents or collisions. Never use the product in a moving vehicle if doing so could distract the driver of the vehicle. Adequately secure the product in the vehicle to prevent injuries or other damage in the event of an accident.

### Waste disposal/Environmental protection

1. Specially marked equipment has a battery or accumulator that must not be disposed of with unsorted municipal waste, but must be collected separately. It may only be disposed of at a suitable collection point or via a Rohde & Schwarz customer service center.
2. Waste electrical and electronic equipment must not be disposed of with unsorted municipal waste, but must be collected separately. Rohde & Schwarz GmbH & Co. KG has developed a disposal concept and takes full responsibility for take-back obligations and disposal obligations for manufacturers within the EU. Contact your Rohde & Schwarz customer service center for environmentally responsible disposal of the product.
3. If products or their components are mechanically and/or thermally processed in a manner that goes beyond their intended use, hazardous substances (heavy-metal dust such as lead, beryllium, nickel) may be released. For this reason, the product may only be disassembled by specially trained personnel. Improper disassembly may be hazardous to your health. National waste disposal regulations must be observed.
4. If handling the product releases hazardous substances or fuels that must be disposed of in a special way, e.g. coolants or engine oils that must be replenished regularly, the safety instructions of the manufacturer of the hazardous substances or fuels and the applicable regional waste disposal regulations must be observed. Also observe the relevant safety instructions in the product documentation. The improper disposal of hazardous substances or fuels can cause health problems and lead to environmental damage.

For additional information about environmental protection, visit the Rohde & Schwarz website.

# Instrucciones de seguridad elementales

## **¡Es imprescindible leer y cumplir las siguientes instrucciones e informaciones de seguridad!**

El principio del grupo de empresas Rohde & Schwarz consiste en tener nuestros productos siempre al día con los estándares de seguridad y de ofrecer a nuestros clientes el máximo grado de seguridad. Nuestros productos y todos los equipos adicionales son siempre fabricados y examinados según las normas de seguridad vigentes. Nuestro sistema de garantía de calidad controla constantemente que sean cumplidas estas normas. El presente producto ha sido fabricado y examinado según el certificado de conformidad adjunto de la UE y ha salido de nuestra planta en estado impecable según los estándares técnicos de seguridad. Para poder preservar este estado y garantizar un funcionamiento libre de peligros, el usuario deberá atenerse a todas las indicaciones, informaciones de seguridad y notas de alerta. El grupo de empresas Rohde & Schwarz está siempre a su disposición en caso de que tengan preguntas referentes a estas informaciones de seguridad.









Además queda en la responsabilidad del usuario utilizar el producto en la forma debida. Este producto está destinado exclusivamente al uso en la industria y el laboratorio o, si ha sido expresamente autorizado, para aplicaciones de campo y de ninguna manera deberá ser utilizado de modo que alguna persona/cosa pueda sufrir daño. El uso del producto fuera de sus fines definidos o sin tener en cuenta las instrucciones del fabricante queda en la responsabilidad del usuario. El fabricante no se hace en ninguna forma responsable de consecuencias a causa del mal uso del producto.

Se parte del uso correcto del producto para los fines definidos si el producto es utilizado conforme a las indicaciones de la correspondiente documentación del producto y dentro del margen de rendimiento definido (ver hoja de datos, documentación, informaciones de seguridad que siguen). El uso del producto hace necesarios conocimientos técnicos y ciertos conocimientos del idioma inglés. Por eso se debe tener en cuenta que el producto solo pueda ser operado por personal especializado o personas instruidas en profundidad con las capacidades correspondientes. Si fuera necesaria indumentaria de seguridad para el uso de productos de Rohde & Schwarz, encontraría la información debida en la documentación del producto en el capítulo correspondiente. Guarde bien las informaciones de seguridad elementales, así como la documentación del producto, y entréguelas a usuarios posteriores.



## Instrucciones de seguridad elementales

Tener en cuenta las informaciones de seguridad sirve para evitar en lo posible lesiones o daños por peligros de toda clase. Por eso es imprescindible leer detalladamente y comprender por completo las siguientes informaciones de seguridad antes de usar el producto, y respetarlas durante el uso del producto. Deberán tenerse en cuenta todas las demás informaciones de seguridad, como p. ej. las referentes a la protección de personas, que encontrarán en el capítulo correspondiente de la documentación del producto y que también son de obligado cumplimiento. En las presentes informaciones de seguridad se recogen todos los objetos que distribuye el grupo de empresas Rohde & Schwarz bajo la denominación de "producto", entre ellos también aparatos, instalaciones así como toda clase de accesorios. Los datos específicos del producto figuran en la hoja de datos y en la documentación del producto.

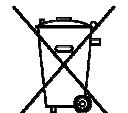
### Símbolos y definiciones de seguridad

Símbolo	Significado	Símbolo	Significado
	Aviso: punto de peligro general Observar la documentación del producto	○	Tensión de alimentación de PUESTA EN MARCHA / PARADA
	Atención en el manejo de dispositivos de peso elevado	⏻	Indicación de estado de espera (standby)
	Peligro de choque eléctrico	— — —	Corriente continua (DC)
	Advertencia: superficie caliente	~	Corriente alterna (AC)
	Conexión a conductor de protección	⎓	Corriente continua / Corriente alterna (DC/AC)
	Conexión a tierra		El aparato está protegido en su totalidad por un aislamiento doble (reforzado)
	Conexión a masa		Distintivo de la UE para baterías y acumuladores Más información en la sección "Eliminación/protección del medio ambiente", punto 1.

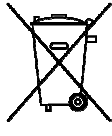
## Instrucciones de seguridad elementales

Símbolo	Significado	Símbolo	Significado
	Aviso: Cuidado en el manejo de dispositivos sensibles a la electrostática (ESD)	 	Distintivo de la UE para la eliminación por separado de dispositivos eléctricos y electrónicos  Más información en la sección "Eliminación/protección del medio ambiente", punto 2.
	Advertencia: rayo láser  Más información en la sección "Funcionamiento", punto 7.		

### Palabras de señal y su significado

En la documentación del producto se utilizan las siguientes palabras de señal con el fin de advertir contra riesgos y peligros.



PELIGRO identifica un peligro inminente con riesgo elevado que provocará muerte o lesiones graves si no se evita.



ADVERTENCIA identifica un posible peligro con riesgo medio de provocar muerte o lesiones (graves) si no se evita.



ATENCIÓN identifica un peligro con riesgo reducido de provocar lesiones leves o moderadas si no se evita.



AVISO indica la posibilidad de utilizar mal el producto y, como consecuencia, dañarlo.  
En la documentación del producto se emplea de forma sinónima el término CUIDADO.

Las palabras de señal corresponden a la definición habitual para aplicaciones civiles en el área económica europea. Pueden existir definiciones diferentes a esta definición en otras áreas económicas o en aplicaciones militares. Por eso se deberá tener en cuenta que las palabras de señal aquí descritas sean utilizadas siempre solamente en combinación con la correspondiente documentación del producto y solamente en combinación con el producto correspondiente. La utilización de las palabras de señal en combinación con productos o documentaciones que no les correspondan puede llevar a interpretaciones equivocadas y tener por consecuencia daños en personas u objetos.

## Instrucciones de seguridad elementales

### Estados operativos y posiciones de funcionamiento

*El producto solamente debe ser utilizado según lo indicado por el fabricante respecto a los estados operativos y posiciones de funcionamiento sin que se obstruya la ventilación. Si no se siguen las indicaciones del fabricante, pueden producirse choques eléctricos, incendios y/o lesiones graves con posible consecuencia de muerte. En todos los trabajos deberán ser tenidas en cuenta las normas nacionales y locales de seguridad del trabajo y de prevención de accidentes.*

1. Si no se convino de otra manera, es para los productos Rohde & Schwarz válido lo que sigue:  
como posición de funcionamiento se define por principio la posición con el suelo de la caja para abajo, modo de protección IP 2X, uso solamente en estancias interiores, utilización hasta 2000 m sobre el nivel del mar, transporte hasta 4500 m sobre el nivel del mar. Se aplicará una tolerancia de  $\pm 10\%$  sobre el voltaje nominal y de  $\pm 5\%$  sobre la frecuencia nominal. Categoría de sobrecarga eléctrica 2, índice de suciedad 2.
2. No sitúe el producto encima de superficies, vehículos, estantes o mesas, que por sus características de peso o de estabilidad no sean aptos para él. Siga siempre las instrucciones de instalación del fabricante cuando instale y asegure el producto en objetos o estructuras (p. ej. paredes y estantes). Si se realiza la instalación de modo distinto al indicado en la documentación del producto, se pueden causar lesiones o, en determinadas circunstancias, incluso la muerte.
3. No ponga el producto sobre aparatos que generen calor (p. ej. radiadores o calefactores). La temperatura ambiente no debe superar la temperatura máxima especificada en la documentación del producto o en la hoja de datos. En caso de sobrecalentamiento del producto, pueden producirse choques eléctricos, incendios y/o lesiones graves con posible consecuencia de muerte.

### Seguridad eléctrica

*Si no se siguen (o se siguen de modo insuficiente) las indicaciones del fabricante en cuanto a seguridad eléctrica, pueden producirse choques eléctricos, incendios y/o lesiones graves con posible consecuencia de muerte.*

1. Antes de la puesta en marcha del producto se deberá comprobar siempre que la tensión preseleccionada en el producto coincida con la de la red de alimentación eléctrica. Si es necesario modificar el ajuste de tensión, también se deberán cambiar en caso dado los fusibles correspondientes del producto.

## Instrucciones de seguridad elementales

2. Los productos de la clase de protección I con alimentación móvil y enchufe individual solamente podrán enchufarse a tomas de corriente con contacto de seguridad y con conductor de protección conectado.
3. Queda prohibida la interrupción intencionada del conductor de protección, tanto en la toma de corriente como en el mismo producto. La interrupción puede tener como consecuencia el riesgo de que el producto sea fuente de choques eléctricos. Si se utilizan cables alargadores o regletas de enchufe, deberá garantizarse la realización de un examen regular de los mismos en cuanto a su estado técnico de seguridad.
4. Si el producto no está equipado con un interruptor para desconectarlo de la red, o bien si el interruptor existente no resulta apropiado para la desconexión de la red, el enchufe del cable de conexión se deberá considerar como un dispositivo de desconexión.  
El dispositivo de desconexión se debe poder alcanzar fácilmente y debe estar siempre bien accesible. Si, p. ej., el enchufe de conexión a la red es el dispositivo de desconexión, la longitud del cable de conexión no debe superar 3 m).  
Los interruptores selectores o electrónicos no son aptos para el corte de la red eléctrica. Si se integran productos sin interruptor en bastidores o instalaciones, se deberá colocar el interruptor en el nivel de la instalación.
5. No utilice nunca el producto si está dañado el cable de conexión a red. Compruebe regularmente el correcto estado de los cables de conexión a red. Asegúrese, mediante las medidas de protección y de instalación adecuadas, de que el cable de conexión a red no pueda ser dañado o de que nadie pueda ser dañado por él, p. ej. al tropezar o por un choque eléctrico.
6. Solamente está permitido el funcionamiento en redes de alimentación TN/TT aseguradas con fusibles de 16 A como máximo (utilización de fusibles de mayor amperaje solo previa consulta con el grupo de empresas Rohde & Schwarz).
7. Nunca conecte el enchufe en tomas de corriente sucias o llenas de polvo. Introduzca el enchufe por completo y fuertemente en la toma de corriente. La no observación de estas medidas puede provocar chispas, fuego y/o lesiones.
8. No sobrecargue las tomas de corriente, los cables alargadores o las regletas de enchufe ya que esto podría causar fuego o choques eléctricos.
9. En las mediciones en circuitos de corriente con una tensión  $U_{\text{eff}} > 30 \text{ V}$  se deberán tomar las medidas apropiadas para impedir cualquier peligro (p. ej. medios de medición adecuados, seguros, limitación de tensión, corte protector, aislamiento etc.).



## Instrucciones de seguridad elementales

10. Para la conexión con dispositivos informáticos como un PC o un ordenador industrial, debe comprobarse que éstos cumplan los estándares IEC60950-1/EN60950-1 o IEC61010-1/EN 61010-1 válidos en cada caso.
11. A menos que esté permitido expresamente, no retire nunca la tapa ni componentes de la carcasa mientras el producto esté en servicio. Esto pone a descubierto los cables y componentes eléctricos y puede causar lesiones, fuego o daños en el producto.
12. Si un producto se instala en un lugar fijo, se deberá primero conectar el conductor de protección fijo con el conductor de protección del producto antes de hacer cualquier otra conexión. La instalación y la conexión deberán ser efectuadas por un electricista especializado.
13. En el caso de dispositivos fijos que no estén provistos de fusibles, interruptor automático ni otros mecanismos de seguridad similares, el circuito de alimentación debe estar protegido de modo que todas las personas que puedan acceder al producto, así como el producto mismo, estén a salvo de posibles daños.
14. Todo producto debe estar protegido contra sobretensión (debida p. ej. a una caída del rayo) mediante los correspondientes sistemas de protección. Si no, el personal que lo utilice quedará expuesto al peligro de choque eléctrico.
15. No debe introducirse en los orificios de la caja del aparato ningún objeto que no esté destinado a ello. Esto puede producir cortocircuitos en el producto y/o puede causar choques eléctricos, fuego o lesiones.
16. Salvo indicación contraria, los productos no están impermeabilizados (ver también el capítulo "Estados operativos y posiciones de funcionamiento", punto 1). Por eso es necesario tomar las medidas necesarias para evitar la entrada de líquidos. En caso contrario, existe peligro de choque eléctrico para el usuario o de daños en el producto, que también pueden redundar en peligro para las personas.
17. No utilice el producto en condiciones en las que pueda producirse o ya se hayan producido condensaciones sobre el producto o en el interior de éste, como p. ej. al desplazarlo de un lugar frío a otro caliente. La entrada de agua aumenta el riesgo de choque eléctrico.
18. Antes de la limpieza, desconecte por completo el producto de la alimentación de tensión (p. ej. red de alimentación o batería). Realice la limpieza de los aparatos con un paño suave, que no se deshilache. No utilice bajo ningún concepto productos de limpieza químicos como alcohol, acetona o diluyentes para lacas nitrocelulósicas.

## Instrucciones de seguridad elementales

### Funcionamiento

1. El uso del producto requiere instrucciones especiales y una alta concentración durante el manejo. Debe asegurarse que las personas que manejen el producto estén a la altura de los requerimientos necesarios en cuanto a aptitudes físicas, psíquicas y emocionales, ya que de otra manera no se pueden excluir lesiones o daños de objetos. El empresario u operador es responsable de seleccionar el personal usuario apto para el manejo del producto.
2. Antes de desplazar o transportar el producto, lea y tenga en cuenta el capítulo "Transporte".
3. Como con todo producto de fabricación industrial no puede quedar excluida en general la posibilidad de que se produzcan alergias provocadas por algunos materiales empleados —los llamados alérgenos (p. ej. el níquel)—. Si durante el manejo de productos Rohde & Schwarz se producen reacciones alérgicas, como p. ej. irritaciones cutáneas, estornudos continuos, enrojecimiento de la conjuntiva o dificultades respiratorias, debe avisarse inmediatamente a un médico para investigar las causas y evitar cualquier molestia o daño a la salud.
4. Antes de la manipulación mecánica y/o térmica o el desmontaje del producto, debe tenerse en cuenta imprescindiblemente el capítulo "Eliminación/protección del medio ambiente", punto 1.
5. Ciertos productos, como p. ej. las instalaciones de radiocomunicación RF, pueden a causa de su función natural, emitir una radiación electromagnética aumentada. Deben tomarse todas las medidas necesarias para la protección de las mujeres embarazadas. También las personas con marcapasos pueden correr peligro a causa de la radiación electromagnética. El empresario/operador tiene la obligación de evaluar y señalar las áreas de trabajo en las que exista un riesgo elevado de exposición a radiaciones.
6. Tenga en cuenta que en caso de incendio pueden desprenderse del producto sustancias tóxicas (gases, líquidos etc.) que pueden generar daños a la salud. Por eso, en caso de incendio deben usarse medidas adecuadas, como p. ej. máscaras antigás e indumentaria de protección.

## Instrucciones de seguridad elementales

7. Los productos con láser están provistos de indicaciones de advertencia normalizadas en función de la clase de láser del que se trate. Los rayos láser pueden provocar daños de tipo biológico a causa de las propiedades de su radiación y debido a su concentración extrema de potencia electromagnética. En caso de que un producto Rohde & Schwarz contenga un producto láser (p. ej. un lector de CD/DVD), no debe usarse ninguna otra configuración o función aparte de las descritas en la documentación del producto, a fin de evitar lesiones (p. ej. debidas a irradiación láser).
8. Clases CEM (según CISPR 11)  
Clase A: dispositivo apropiado para el uso en cualquier zona excepto en áreas residenciales y en aquellas zonas que se encuentran conectadas a una red de suministro de baja tensión que alimenta un edificio de viviendas.  
Clase B: dispositivo apropiado para el uso en áreas residenciales y en aquellas zonas que se encuentran conectadas a una red de suministro de baja tensión que alimenta un edificio de viviendas.

### Reparación y mantenimiento

1. El producto solamente debe ser abierto por personal especializado con autorización para ello. Antes de manipular el producto o abrirlo, es obligatorio desconectarlo de la tensión de alimentación, para evitar toda posibilidad de choque eléctrico.
2. El ajuste, el cambio de partes, el mantenimiento y la reparación deberán ser efectuadas solamente por electricistas autorizados por Rohde & Schwarz. Si se reponen partes con importancia para los aspectos de seguridad (p. ej. el enchufe, los transformadores o los fusibles), solamente podrán ser sustituidos por partes originales. Después de cada cambio de partes relevantes para la seguridad deberá realizarse un control de seguridad (control a primera vista, control del conductor de protección, medición de resistencia de aislamiento, medición de la corriente de fuga, control de funcionamiento). Con esto queda garantizada la seguridad del producto.

### Baterías y acumuladores o celdas

*Si no se siguen (o se siguen de modo insuficiente) las indicaciones en cuanto a las baterías y acumuladores o celdas, pueden producirse explosiones, incendios y/o lesiones graves con posible consecuencia de muerte. El manejo de baterías y acumuladores con electrolitos alcalinos (p. ej. celdas de litio) debe seguir el estándar EN 62133.*

## Instrucciones de seguridad elementales

1. No deben desmontarse, abrirse ni triturarse las celdas.
2. Las celdas o baterías no deben someterse a calor ni fuego. Debe evitarse el almacenamiento a la luz directa del sol. Las celdas y baterías deben mantenerse limpias y secas. Limpiar las conexiones sucias con un paño seco y limpio.
3. Las celdas o baterías no deben cortocircuitarse. Es peligroso almacenar las celdas o baterías en estuches o cajones en cuyo interior puedan cortocircuitarse por contacto recíproco o por contacto con otros materiales conductores. No deben extraerse las celdas o baterías de sus embalajes originales hasta el momento en que vayan a utilizarse.
4. Las celdas o baterías no deben someterse a impactos mecánicos fuertes indebidos.
5. En caso de falta de estanqueidad de una celda, el líquido vertido no debe entrar en contacto con la piel ni los ojos. Si se produce contacto, lavar con agua abundante la zona afectada y avisar a un médico.
6. En caso de cambio o recarga inadecuados, las celdas o baterías que contienen electrolitos alcalinos (p. ej. las celdas de litio) pueden explotar. Para garantizar la seguridad del producto, las celdas o baterías solo deben ser sustituidas por el tipo Rohde & Schwarz correspondiente (ver lista de recambios).
7. Las baterías y celdas deben reciclarse y no deben tirarse a la basura doméstica. Las baterías o acumuladores que contienen plomo, mercurio o cadmio deben tratarse como residuos especiales. Respete en esta relación las normas nacionales de eliminación y reciclaje.

### Transporte

1. El producto puede tener un peso elevado. Por eso es necesario desplazarlo o transportarlo con precaución y, si es necesario, usando un sistema de elevación adecuado (p. ej. una carretilla elevadora), a fin de evitar lesiones en la espalda u otros daños personales.
2. Las asas instaladas en los productos sirven solamente de ayuda para el transporte del producto por personas. Por eso no está permitido utilizar las asas para la sujeción en o sobre medios de transporte como p. ej. grúas, carretillas elevadoras de horquilla, carros etc. Es responsabilidad suya fijar los productos de manera segura a los medios de transporte o elevación. Para evitar daños personales o daños en el producto, siga las instrucciones de seguridad del fabricante del medio de transporte o elevación utilizado.

## **Instrucciones de seguridad elementales**

3. Si se utiliza el producto dentro de un vehículo, recae de manera exclusiva en el conductor la responsabilidad de conducir el vehículo de manera segura y adecuada. El fabricante no asumirá ninguna responsabilidad por accidentes o colisiones. No utilice nunca el producto dentro de un vehículo en movimiento si esto pudiera distraer al conductor. Asegure el producto dentro del vehículo debidamente para evitar, en caso de un accidente, lesiones u otra clase de daños.

### **Eliminación/protección del medio ambiente**

1. Los dispositivos marcados contienen una batería o un acumulador que no se debe desechar con los residuos domésticos sin clasificar, sino que debe ser recogido por separado. La eliminación se debe efectuar exclusivamente a través de un punto de recogida apropiado o del servicio de atención al cliente de Rohde & Schwarz.
2. Los dispositivos eléctricos usados no se deben desechar con los residuos domésticos sin clasificar, sino que deben ser recogidos por separado. Rohde & Schwarz GmbH & Co.KG ha elaborado un concepto de eliminación de residuos y asume plenamente los deberes de recogida y eliminación para los fabricantes dentro de la UE. Para desechar el producto de manera respetuosa con el medio ambiente, diríjase a su servicio de atención al cliente de Rohde & Schwarz.
3. Si se trabaja de manera mecánica y/o térmica cualquier producto o componente más allá del funcionamiento previsto, pueden liberarse sustancias peligrosas (polvos con contenido de metales pesados como p. ej. plomo, berilio o níquel). Por eso el producto solo debe ser desmontado por personal especializado con formación adecuada. Un desmontaje inadecuado puede ocasionar daños para la salud. Se deben tener en cuenta las directivas nacionales referentes a la eliminación de residuos.
4. En caso de que durante el trato del producto se formen sustancias peligrosas o combustibles que deban tratarse como residuos especiales (p. ej. refrigerantes o aceites de motor con intervalos de cambio definidos), deben tenerse en cuenta las indicaciones de seguridad del fabricante de dichas sustancias y las normas regionales de eliminación de residuos. Tenga en cuenta también en caso necesario las indicaciones de seguridad especiales contenidas en la documentación del producto. La eliminación incorrecta de sustancias peligrosas o combustibles puede causar daños a la salud o daños al medio ambiente.

Se puede encontrar más información sobre la protección del medio ambiente en la página web de Rohde & Schwarz.

## Safety Instructions for Stacking Instruments

**⚠ WARNING**

### Danger of injury

Instruments may slip if they are stacked on top of each other.

Place the instrument on a stable, even surface. Stack the instruments according to their size, with the largest instrument on the bottom. Do not stack more than three instruments directly on top of each other. Instruments may only be stacked if their feet and housing allow horizontal stacking. If these conditions are not met, the instruments must be installed in a rack in order to avoid the risk of personal injury and material damage.

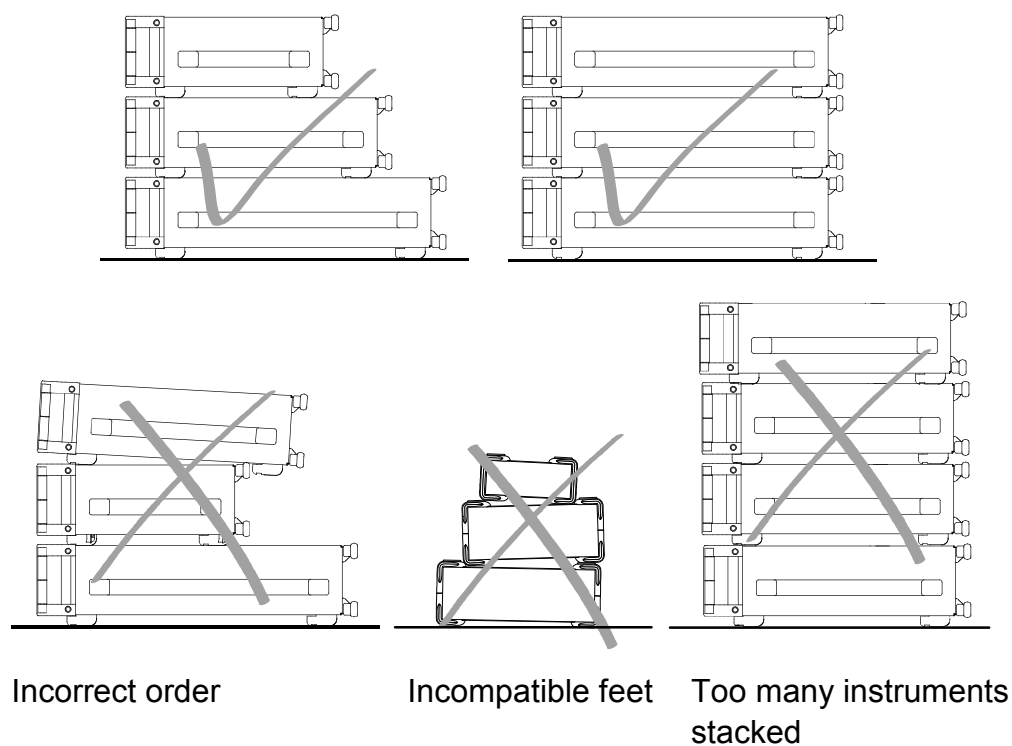

## Informaciones de seguridad para el amontonamiento de aparatos

### **⚠ ADVERTENCIA**

#### **Peligro de heridas**

Los aparatos pueden desplazarse al ser amontonados.

Posicionar los aparatos sobre una superficie estable y lisa. Amontonar los aparatos por orden de su tamaño. No amontonar nunca más de tres aparatos uno sobre el otro. Los aparatos solamente deberán ser amontonados, si los piés y la caja del aparato correspondiente hacen posible amontonarlos de forma horizontal. Si no se cumplen estas condiciones, deberán ser montados los aparatos en una caja apta para este propósito. De esta manera evitarán el riesgo de daños en personas y daños en el aparato.

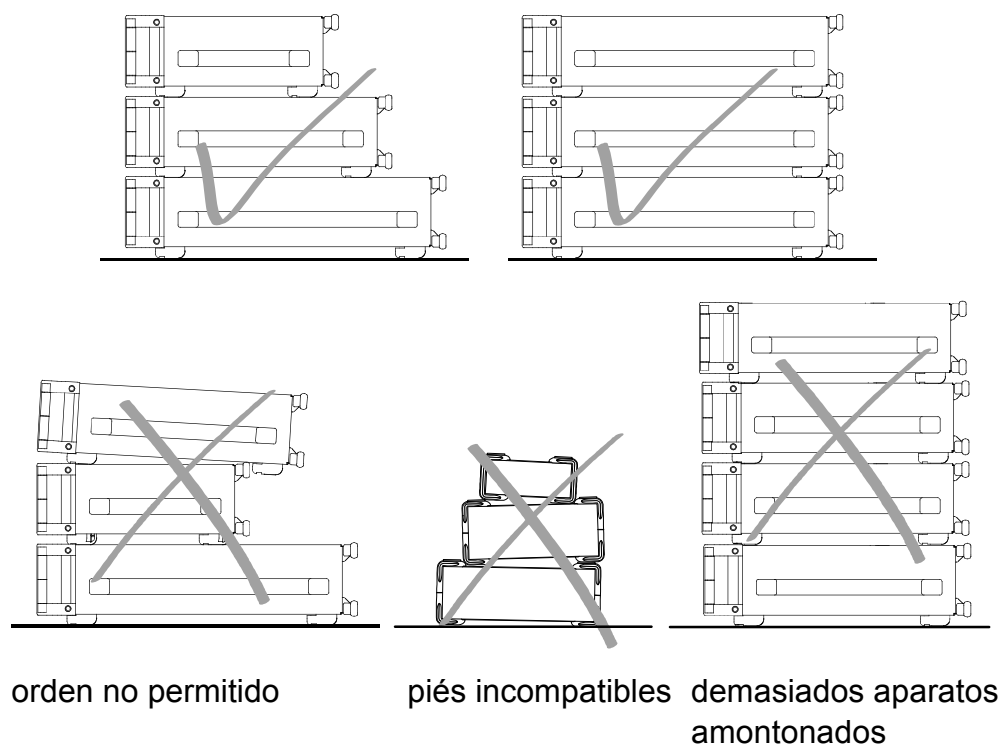

# Customer Support

## Technical support – where and when you need it

For quick, expert help with any Rohde & Schwarz equipment, contact one of our Customer Support Centers. A team of highly qualified engineers provides telephone support and will work with you to find a solution to your query on any aspect of the operation, programming or applications of Rohde & Schwarz equipment.

## Up-to-date information and upgrades

To keep your instrument up-to-date and to be informed about new application notes related to your instrument, please send an e-mail to the Customer Support Center stating your instrument and your wish.

We will take care that you will get the right information.

### Europe, Africa, Middle East

Phone +49 89 4129 12345  
[customersupport@rohde-schwarz.com](mailto:customersupport@rohde-schwarz.com)

### North America

Phone 1-888-TEST-RSA (1-888-837-8772)  
[customer.support@rsa.rohde-schwarz.com](mailto:customer.support@rsa.rohde-schwarz.com)

### Latin America

Phone +1-410-910-7988  
[customersupport.la@rohde-schwarz.com](mailto:customersupport.la@rohde-schwarz.com)

### Asia/Pacific

Phone +65 65 13 04 88  
[customersupport.asia@rohde-schwarz.com](mailto:customersupport.asia@rohde-schwarz.com)

### China

Phone +86-800-810-8228 /  
+86-400-650-5896  
[customersupport.china@rohde-schwarz.com](mailto:customersupport.china@rohde-schwarz.com)





# Qualitätszertifikat

## Certificate of quality

## Certificat de qualité

Certified Quality System  
**ISO 9001**

Certified Environmental System  
**ISO 14001**

### Sehr geehrter Kunde,

Sie haben sich für den Kauf eines Rohde & Schwarz-Produktes entschieden. Sie erhalten damit ein nach modernsten Fertigungsmethoden hergestelltes Produkt. Es wurde nach den Regeln unseres Qualitätsmanagementsystems entwickelt, gefertigt und geprüft. Das Rohde & Schwarz-Qualitätsmanagementsystem ist unter anderem nach ISO9001 und ISO 14001 zertifiziert.

### Der Umwelt verpflichtet

- Energie-effiziente, RoHS-konforme Produkte
- Kontinuierliche Weiterentwicklung nachhaltiger Umweltkonzepte
- ISO 14001-zertifiziertes Umweltmanagementsystem

### Dear customer,

You have decided to buy a Rohde & Schwarz product. You are thus assured of receiving a product that is manufactured using the most modern methods available. This product was developed, manufactured and tested in compliance with our quality management system standards. The Rohde & Schwarz quality management system is certified according to standards such as ISO9001 and ISO14001.

### Environmental commitment

- Energy-efficient products
- Continuous improvement in environmental sustainability
- ISO 14001-certified environmental management system

### Cher client,

Vous avez choisi d'acheter un produit Rohde & Schwarz. Vous disposez donc d'un produit fabriqué d'après les méthodes les plus avancées. Le développement, la fabrication et les tests respectent nos normes de gestion qualité. Le système de gestion qualité de Rohde & Schwarz a été homologué, entre autres, conformément aux normes ISO9001 et ISO 14001.

### Engagement écologique

- Produits à efficience énergétique
- Amélioration continue de la durabilité environnementale
- Système de gestion de l'environnement certifié selon ISO 14001





# ROHDE & SCHWARZ

EU-KONFORMITÄT SERKLÄRUNG



Certificate No.: 2007-10

This is to certify that:

Equipment type	Stock No.	Designation
ETL	2112.0004.13	TV Analyzer
ETL-B201	2112.0304.02	Additional Interfaces Digital TV
ETL-B203	2112.0327.02/03	RF Preselector
ETL-B209	2112.0291.02	Harddisk
ETL-B210	2112.0104.02	Digital Demodulator for Single Carrier
ETL-B211	2112.0110.02	Digital Demodulator for DMB-T
ETL-B212	2112.0127.02	Digital Demodulator for Single Carrier and DMB-T
ETL-B215	2112.0156.02	Digital Demodulator for DTMB
ETL-B216	2112.0162.02	Digital Demodulator for Single Carrier and DTMB
ETL-B235	2112.0262.02	Li-Ion Battery Pack 10 Ah
ETL-B280	2112.0362.02	MPEG Processing Board
ETL-B281	2112.0356.02	Video and Audio Hardware Decoder
ETL-B310	2112.0340.02	FPGA Ext/FM high SNR Board

complies with the provisions of the Directive of the Council of the European Union on the approximation of the laws of the Member States

- relating to electrical equipment for use within defined voltage limits (2006/95/EC)
- relating to electromagnetic compatibility (2004/108/EC)

Conformity is proven by compliance with the following standards:

EN 61010-1:2001  
EN 61326-1:2006  
EN 61326-2-1:2006  
EN 55011:2007  
EN 61000-3-2:2006  
EN 61000-3-3:1995 + A1:2001 + A2:2005

For the assessment of electromagnetic compatibility, the limits of radio interference for Class A equipment as well as the immunity to interference for operation in industry have been used as a basis.

Affixing the EC conformity mark as from 2007

**ROHDE & SCHWARZ GmbH & Co. KG**  
Mühldorfstr. 15, D-81671 München

Munich, 2011-08-31

Central Quality Management GF-QP / Radde



**ROHDE & SCHWARZ**  
EC Certificate of Conformity



Certificate No.: 2008-22

This is to certify that:

Equipment type	Stock No.	Designation
ETL-B230	2112.0256.02	DC Power Supply

complies with the provisions of the Directive of the Council of the European Union on the approximation of the laws of the Member States

- relating to electromagnetic compatibility  
(2004/108/EC)

Conformity is proven by compliance with the following standards:

EN 61326 : 1997 + A1 : 1998 + A2 : 2001 + A3 : 2003  
EN 55011 : 1998 + A1 : 1999 + A2 : 2002, Klasse A

For the assessment of electromagnetic compatibility, the limits of radio interference for Class A equipment as well as the immunity to interference for operation in industry have been used as a basis.

The product complies with the requirements of the Directive relating to the radio interference of vehicles (72/245/EEC adapted by 2004/104/EC, 2005/49/EC, 2005/83/EC, 2006/28/EC, after-market equipment in accordance with Annex I, paragraph 3.2.9 of the Directive); proof of compliance provided by the measurements as described in Annex I, paragraphs 6.5, 6.6, 6.8, 6.9.

Affixing the EC conformity mark as from 2008

**ROHDE & SCHWARZ GmbH & Co. KG**  
**Mühldorfstr. 15, D-81671 München**

Munich, 2008-04-02

Central Quality Management MF-QZ / Radde



Bescheinigung Nr. / Attestation No.: 7004-08

Antragsteller / Applicant:

ROHDE & SCHWARZ GmbH & Co. KG, PF 80 14 69, D-81614 München

Typ / Type:

ETL-B230 (2112.0256.02)

Blatt / Sheet 1/1

## BESCHEINIGUNG ATTESTATION

GEMÄSS RICHTLINIE 2004/104/EG, ANHANG I, 3.2.9  
WITH REGARD TO DIRECTIVE 2004/104/EC, ANNEX I, 3.2.9

Nr. / No. 7004-08

**Antragsteller**  
*Applicant*

ROHDE & SCHWARZ

**Allgemeine Beschreibung des Produkts**  
*General description of the product*

DC-Netzteil  
DC Power Supply

**Typ**  
*Type*

ETL-B230 (2112.0256.02)

**Vom Antragsteller eingereichte Informationen**  
*Information submitted by the applicant*

Systembeschreibung  
System description

**Diese EUB kann für jeden Fahrzeugtyp mit folgenden Einschränkungen verwendet werden**  
*This ESA can be used on any vehicle type with the following restrictions*

12V, Masse der Batterie negativ an der Karosserie  
12V, battery negative on the body

**Einbauvorschriften (gegebenenfalls)**  
*Installation conditions, if any*

nicht vorhanden  
not applicable

Wir bestätigen, dass das oben beschriebene Produkt keine Funktionen im Zusammenhang mit Störfestigkeit gemäß Richtlinie 72/245/EWG in der Fassung der Richtlinie 2004/104/EG betrifft. Prüfungen der Störfestigkeit gemäß dieser Richtlinie sind nicht erforderlich.

*We confirm that the product described above is not immunity-related according to Directive 72/245/EEC, as last amended by Directive 2004/104/EC. Any testing according to immunity as defined in this Directive is not required.*

**Der Sachverständige**  
*The Expert*

  
Dipl.-Ing. (FH) Stefan Rainer



München, 18.03.2008

# Table of Contents

<b>Documentation Overview .....</b>	<b>7</b>
<b>Conventions Used in the Documentation .....</b>	<b>8</b>
<b>1 Setting Up the Instrument .....</b>	<b>9</b>
<b>1.1 Unpacking the Instrument .....</b>	<b>9</b>
1.1.1 Checking the Accessories .....	10
1.1.2 Ship Damage Inspection .....	10
1.1.3 Warranty.....	11
1.1.4 Recommended Calibration Interval .....	11
<b>1.2 Putting Up the Instrument .....</b>	<b>11</b>
1.2.1 Placing the Instrument on a Bench Top .....	11
1.2.2 Mounting the Instrument in a Rack.....	12
<b>2 Interfaces and Connectors .....</b>	<b>13</b>
<b>2.1 Front Panel .....</b>	<b>13</b>
2.1.1 Front Panel Keys.....	14
2.1.2 Front Panel Connectors .....	22
<b>2.2 Rear Panel.....</b>	<b>25</b>
2.2.1 Standard Rear Panel Connectors .....	26
2.2.2 DC Power Supply (R&S ETL-B230 Option).....	29
2.2.3 GPIB Interface (R&S FSL-B10 Option ) .....	30
2.2.4 EXT REF with OCXO (R&S FSL-B4 Option).....	30
2.2.5 Bundle Interface Digital (R&S ETL-B201 Option, MOD 02).....	31
2.2.6 Bundle Interface Digital (R&S ETL-B201 Option, MOD 03).....	33
2.2.7 Additional Interfaces (R&S FSL-B5 Option).....	36
2.2.8 MPEG Processing Board (R&S ETL-B280 Option) .....	38
2.2.9 Battery Pack (R&S ETL-B235 Option).....	39

<b>3</b>	<b>Connecting the Instrument</b>	<b>41</b>
<b>3.1</b>	<b>Connecting to the Power Supply</b>	<b>41</b>
3.1.1	Connecting to the AC Power Supply	41
<b>3.2</b>	<b>Connecting External Devices</b>	<b>42</b>
<b>4</b>	<b>Switching On or Off the Instrument</b>	<b>45</b>
<b>4.1</b>	<b>Instrument Modes</b>	<b>45</b>
<b>4.2</b>	<b>Switching On the Instrument</b>	<b>46</b>
<b>4.3</b>	<b>Switching Off the Instrument</b>	<b>46</b>
4.3.1	Switching into Standby Mode	46
4.3.2	Switching into Off Mode	47
<b>4.4</b>	<b>Behavior of the ON/STANDBY Key</b>	<b>48</b>
<b>4.5</b>	<b>Checking the Provided Options</b>	<b>49</b>
<b>4.6</b>	<b>Turn-On Tests</b>	<b>49</b>
4.6.1	Performing a Self Alignment	49
4.6.2	Performing a Self Test	50
<b>5</b>	<b>Sample Application</b>	<b>51</b>
<b>5.1</b>	<b>Test Setup</b>	<b>51</b>
<b>5.2</b>	<b>Setting the TV Analyzer/Receiver Mode</b>	<b>51</b>
<b>5.3</b>	<b>Performing the Measurement</b>	<b>52</b>
<b>6</b>	<b>Operating the Instrument in a LAN</b>	<b>53</b>
<b>6.1</b>	<b>Connecting the Instrument to the Network</b>	<b>53</b>
<b>6.2</b>	<b>Configuring the Network Card</b>	<b>53</b>
6.2.1	Changing the IP Address and Configuring the Network Protocols (TCP/IP Protocol)	54
6.2.1.1	To Display the Network Address Submenu	54
6.2.1.2	To Configure the Network Protocol in a Network without DHCP Server	54
6.2.1.3	To Configure the Network Protocol in a Network with DHCP Server	55

<b>7 Installed Software .....</b>	<b>57</b>
<b>7.1 Operating System.....</b>	<b>57</b>
7.1.1 Windows XP Start Menu .....	58
7.1.1.1 To Open the Windows XP Start Menu.....	58
7.1.1.2 To Return to the Measurement Screen .....	58
7.1.2 Windows XP Service Packs .....	59
7.1.3 Login .....	59
7.1.3.1 To Deactivate the Automatic Login Mechanism .....	59
7.1.3.2 To Reactivate the Automatic Login mechanism .....	60
<b>7.2 Additional Software.....</b>	<b>60</b>
<b>8 Maintenance .....</b>	<b>61</b>
<b>8.1 Cleaning the Instrument .....</b>	<b>61</b>
<b>8.2 Replacing the Fuses .....</b>	<b>62</b>
<b>8.3 Storing the Instrument.....</b>	<b>62</b>
<b>Index .....</b>	<b>63</b>





# Documentation Overview

The user documentation for the R&S ETL is divided as follows:

- [First Steps](#)
- [Operating Manual](#)
- [Online Help](#)
- [Software Manual](#)

The Basic Safety Instructions are provided in the printed First Steps manual.

## First Steps

This manual is delivered with the instrument in printed form and in PDF format on the CD-ROM. It provides the information needed to set up and start working with the instrument. More detailed descriptions are provided in the Operating Manual. The First Steps manual includes general information (e.g. Safety Instructions).

## Operating Manual

This manual is a supplement to the First Steps manual and is available in PDF format on the CD-ROM delivered with the instrument. The printed manual can be ordered from Rohde & Schwarz GmbH & Co. KG, order number 2112.0079.12.

In this manual, all instrument functions are described in detail. For additional information on default settings and parameters, refer to the data sheets.

## Online Help

The Online Help is part of the firmware. It provides a quick access to the complete description. For detailed information on how to use the Online Help, refer to the Operating Manual, chapter "Operating Concepts", or the Online Help.

## Software Manual

This manual describes the "WiMAX IEEE 802.16 OFDM/OFDMA Application Firmware" option (R&S FSL-K93) and is available in PDF format on the CD-ROM delivered with the instrument.

In this manual, all instrument functions of the "WiMAX IEEE 802.16 OFDM/OFDMA Application Firmware" option are described in detail. For additional information on default settings and parameters, refer to the data sheets.

# Conventions Used in the Documentation

The following conventions are used throughout the R&S ETL documentation:

## Typographical conventions

Convention	Description
<b>Bold</b>	All names of graphical user interface elements both on the screen and on the front and rear panels, such as dialog boxes, softkeys, menus, options, buttons etc., are written in bold letters.
KEYS	Key names are written in capital letters.
<i>Input</i>	Input to be entered by the user is displayed in italics.
File names, commands, program code	File names, commands, coding samples and screen output are distinguished by their font.
<a href="#">Links</a>	Links that you can click are displayed in blue font.
"References"	References to other parts of the documentation are enclosed by parentheses.

## Other conventions

- **Softkeys:** The description of a softkey (Operating Manual and Online Help) always starts with the softkey name, and is followed by explaining text and one or more remote control commands. Each remote command is placed in a single line.
- **Remote commands:** The description of remote control commands (Operating Manual and Online Help) always starts with the command itself, and is followed by explaining text including an example, the characteristics and the mode (standard or only with certain options). The remote commands consist of abbreviations to accelerate the procedure. All parts of the command that have to be entered are in capital letters, the rest is added in small letters to complete the words and transport their meaning.
- **Procedure descriptions:** When describing how to operate the device, several alternative methods may be available to perform the same task. In this case, the procedure using the front panel is described, when possible. Any elements that can be activated by pressing a key can also be clicked using an additionally connected mouse. The alternative procedure using an external keyboard is only described if it deviates from the standard operating procedures as described in the Operating Manual, chapter "Operating Concepts", or the Online Help.

The terms "select" and "press" may refer to any of the described methods, i.e. using a key on the device or on a keyboard, or a mouse pointer in the display.

# 1 Setting Up the Instrument

## **⚠ WARNING**

### **Risk of physical injury**

To avoid physical injury to yourself or others, always follow the instructions provided in the following sections. Furthermore, observe the general safety instructions at the beginning of this manual.

## 1.1 Unpacking the Instrument

The instrument is shipped together with its mandatory accessories in a cardboard box. In order to unpack its contents proceed as follows:

1. Open the cardboard box.
2. Remove the accessories packed into the box.
3. Take the instrument out of the packaging.
4. Remove the shock protectors attached to the instrument.
5. In order to move the handle into the desired position, pull at both side knobs and turn the handle (see [Figure 1-1](#)).

## **⚠ CAUTION**

### **Risk of injuries**

Place the instrument on a stable and level surface before moving the handle. Do not place anything on top of the instrument, if the instrument is not in a level position.

**Figure 1-1: Moving the handle of the instrument**

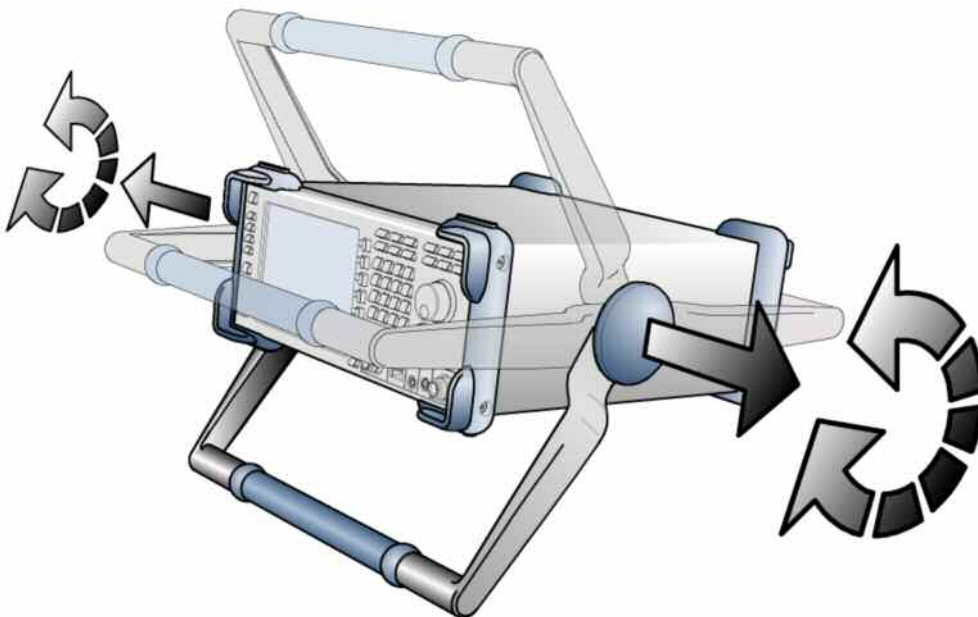

### 1.1.1 Checking the Accessories

The instrument comes with the following accessories:

- Power cable
- First Steps manual
- CD-ROM "R&S ETL TV Analyzer User Documentation"

### 1.1.2 Ship Damage Inspection

Before inspecting the instrument, check the shipping container and cushioning material for damage. If it is damaged, immediately notify the carrier. Keep the box and packing material until you have verified that the contents are complete and until the R&S ETL has been tested electrically and mechanically.

For further transport or shipment of the R&S ETL, the original packaging should be used. Rohde & Schwarz will only accept claims of warranty if the instrument is shipped with sufficient packaging.

Prior to switching on the instrument, check the housing and handle for visible damages or loose parts. If it is damaged, immediately notify the carrier and keep the box and packing material.

Make sure that the fan openings at the sides and at the rear panel of the instrument are not obstructed.

### 1.1.3 Warranty

For information on warranty conditions for the R&S ETL refer to the terms of the delivery documents.

### 1.1.4 Recommended Calibration Interval

For information on the recommended calibration interval for the R&S ETL refer to the R&S ETL data sheet.

## 1.2 Putting Up the Instrument

The instrument can be used in standalone operation or can be installed in a rack.

### 1.2.1 Placing the Instrument on a Bench Top

The instrument is designed for use under general laboratory conditions.

---

**NOTICE****Risk of instrument damage**

Make sure that the ambient conditions required at the site of operation are met:

- The ambient temperature must be in the range specified in the data sheet.
- All fan openings must be unobstructed and the air flow at the side-panel perforations must be unimpeded. The distance to the wall should be at least 10 cm.

Any non-compliance may cause damage to the instrument.

---



To protect DUTs against electrostatic discharge in the event of human contact, use proper protective equipment. For details refer to the instructions at the beginning of this manual.

---

## 1.2.2 Mounting the Instrument in a Rack

The instrument may be installed in a 19" rack mount by using a rack adapter kit (for order no. see data sheet). The installation instructions are part of the adapter kit.

---

**NOTICE****Risk of instrument damage**

For rack installation, ensure that the air flow at the side-panel perforations are not obstructed to avoid overheating of the instrument and wrong measurement results.

---

## 2 Interfaces and Connectors

This chapter describes the front panel and the rear panel of the instrument, including all function keys and connectors.

### 2.1 Front Panel

This section gives a short overview of the keys and connectors on the front panel. A detailed description of the function keys and softkeys is provided in the Operating Manual or the Online Help. For instructions on using the keys for operation and data entry refer to the Operating Manual, chapter "Operating Concepts", or the Online Help.

All connectors on the front panel are placed on the bottom of the right-hand side. The inscriptions on your instrument are in match with the captions of the connector descriptions.

**Figure 2-1: Front panel view**

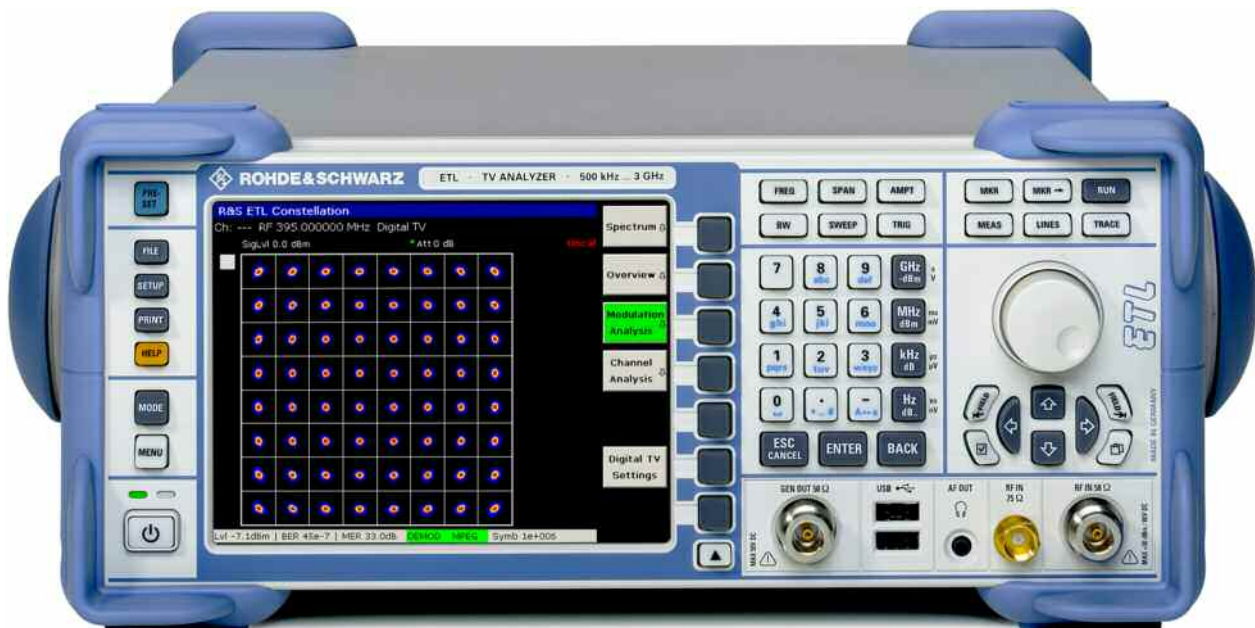

## 2.1.1 Front Panel Keys

### ON/STANDBY key



Switches the instrument on and off. For details on the standby mode (only available when the R&S ETL is supplied with AC power) refer to chapter 4.

### PRESET key



Resets the instrument to the default state.

### FILE key



Provides the functions for storing/loading instrument settings and for managing stored files.

### SETUP key



Provides basic instrument configuration functions:

- Frequency reference (ext/int), noise source, video/IF output (Additional Interfaces option, R&S FSL–B5), transducer factors
- Date, time, display configuration
- LAN interface, remote control (GPIB Interface option, R&S FSL B10)
- Self–alignment
- Firmware update and enabling of options
- Information about instrument configuration incl. firmware version and system error messages
- Service support functions (self test etc.)

### PRINT key



Customizes the printout, selects and configures the printer.



**HELP key**

Displays the Online Help.

**MODE key**

Provides the selection between measurement modes and firmware options.

**MENU key**

Jumps to the highest softkey menu level of the current measurement mode.

**FREQ key**

Sets the center frequency as well as the start and stop frequencies for the frequency range under consideration. This key is also used to set the frequency offset and the signal track function.

**SPAN key**

Sets the frequency span to be analyzed.

**AMPT key**

Sets the reference level, the displayed dynamic range, the RF attenuation and the unit for the level display. Sets the level offset and the input impedance. Activates the preamplifier.

**BW key**

Sets the resolution bandwidth and the video bandwidth.

**SWEEP key**

Sets the sweep time and the number of measurement points. Selects continuous measurement or single measurement.

**TRIG key**

Sets the trigger mode, the trigger threshold, and the trigger delay.

**MKR key**

Sets and positions the absolute and relative measurement markers (markers and delta markers). In addition, the following measurement functions are assigned under this key:

- Frequency counter
- Noise marker
- Phase noise marker
- Fixed reference point for relative measurement markers
- n dB down function
- AF demodulation
- Marker list

**MKR-> key**

Used for search functions of the measurement markers (maximum/minimum of the trace). Assigns the marker frequency to the center frequency, and the marker level to the reference level. Restricts the search area and characterizes the maximum points and minimum points.

**RUN key**

Starts a new measurement.

**MEAS key**

Used to perform advanced measurements:

- Time domain power
- Channel, adjacent channel and multicarrier adjacent channel power
- Occupied bandwidth
- Signal statistics: amplitude probability distribution (APD) and cumulative complementary distribution function (CCDF)
- Carrier to noise spacing
- AM modulation depth
- Third-order intercept point (TOI)
- Harmonics

**LINES key**

Configures display lines and limit lines.

**TRACE key**

Configures the measured data acquisition and the analysis of the measurement data.

**Keypad**

The keypad is used to enter alphanumeric parameters. It contains the following keys:

- Alphanumeric keys  
Enters numbers and (special) characters in edit dialog boxes. For details refer to the Operating Manual, chapter "Operating Concepts", or the Online Help.
- Decimal point  
Inserts a decimal point "." at the cursor position.





- Sign key

Changes the sign of a numeric parameter. In the case of an alphanumeric parameter, inserts a "." at the cursor position.



- Unit keys

These keys add the selected unit to the entered numeric value and complete the entry. In the case of level entries (e.g. in dB) or dimensionless values, all units have the value "1" as multiplying factor. Thus, they have the same function as an ENTER key. The same is true for an alphanumeric entry.

### ESC/CANCEL key



Closes all kinds of dialog boxes, if the edit mode is not active. Quits the edit mode, if the edit mode is active. In dialog boxes that contain a **Cancel** button it activates that button.

### ENTER key



- Concludes the entry of dimensionless entries. The new value is accepted.
- With other entries, this key can be used instead of the **Hz / dB..** unit key.
- In a dialog box, presses the default or focused button.
- In a dialog box, activates the edit mode for the focused area, if available. For details on the edit mode refer to the Operating Manual, chapter "Operating Concepts", or the Online Help.
- In a dialog box, activates or deactivates the selected option of the focused area, if the edit mode is active.

### BACK key



If an alphanumeric entry has already been started, this key deletes the character to the left of the cursor.

If an entry has been completed or not yet started, this key toggles between the currently and the previously entered value (undo function).

## Rotary knob



The rotary knob has several functions:

- Increments (clockwise direction) or decrements (counter-clockwise direction) the instrument parameter at a defined step width in the case of a numeric entry.
- Moves the focus from one element of the graphical user interface to another like the **FIELD RIGHT** and **FIELD LEFT** keys.
- Shifts the selection bar within focused areas (e.g. lists), if the edit mode is activated.
- Shifts markers, limit lines, etc on the screen.
- Acts like the **ENTER** key, when it is pressed. For details refer to the Operating Manual, chapter "Operating Concepts", or the Online Help.
- Moves the scroll bar vertically, if the scroll bar is focused and the edit mode is activated.

For details on the edit mode refer to the Operating Manual, chapter "Operating Concepts", or the Online Help.

## Arrow keys



The **UP ARROW** or **DN ARROW** keys do the following:

- In a numeric edit dialog box, increase or decrease the instrument parameter.
- In a list, scroll forward and backward through the list entries.
- In a table, move the selection bar vertically.
- In windows or dialog boxes with vertical scroll bar, move the scroll bar.

The **LEFT ARROW** or **RIGHT ARROW** keys do the following:

- In an alphanumeric edit dialog box, move the cursor.
- In a list, scroll forward and backward through the list entries.
- In a table, move the selection bar horizontally.
- In windows or dialog boxes with horizontal scroll bar, move the scroll bar.

In **TV Analyzer/Receiver** mode, the arrow keys provide additionally scaling functionality. For details refer to the Operating Manual, chapter "TV/Radio Analyzer/Receiver".

## FIELD keys



Within a dialog box, the **FIELD LEFT** and **FIELD RIGHT** keys do the following.

- The **FIELD LEFT** key moves the focus to the previous element of the graphical user interface (e.g. fields, buttons) in edit mode. The corresponding Windows function is **BACK TAB**.
- The **FIELD RIGHT** key moves the focus to the next element of the graphical user interface in edit mode (e.g. fields, buttons).

**CHECKMARK key**

The **CHECKMARK** key works as follows in dialog boxes:

- Inserts a blank in an edit dialog box. The corresponding Windows function is **SPACE**.
- Selects the option on which the focus is set without closing the dialog box. If more than one option can be chosen, it also deselects a selected option.
- Presses the button on which the focus is set.

**NEXT TAB key**

The **NEXT TAB** key opens the next tab of the dialog box.

For details on the edit mode refer to the Operating Manual, chapter "Operating Concepts", or the Online Help.

## 2.1.2 Front Panel Connectors

### RF IN 50 $\Omega$



The RF input is to be connected to the DUT via a cable equipped with a male N connector. It is AC coupled.

#### **NOTICE**

**Do not overload the input! Risk of damaging the instrument.**

An input DC voltage of 80 V must never be exceeded in order to avoid damage to the instrument. The maximum continuous power at the RF input is 30 dBm (1 W).

A maximum torque of 60 Ncm is recommended. A higher torque may destroy the mating.

In order to avoid EMI, double shielded cables are recommended.

### RF IN 75 $\Omega$



The R&S ETL provides a second RF input with 75  $\Omega$  impedance (R&S ETL-B203 option). It is AC coupled.

In order to avoid EMI, double shielded cables are recommended.



## AF OUT



Headphones equipped with a miniature jack plug can be connected to the AF output female connector. To use the AF OUTPUT, in the setup menu (**SETUP** key), select video output. The output voltage (volume) can be set via the marker menu or the **MENU** key.

### CAUTION

#### Danger of injury

Check the volume setting carefully before putting on the headphones in order to protect your hearing.



This connector cannot be used simultaneously to the IF/Video output connector on the rear panel.

## USB



The front panel provides two female USB connectors to connect devices like keyboard (recommended: R&S PSL-Z2, order number 1157.6870.03) and mouse (recommended: R&S PSL-Z10, order number 1157.7060.03). Also a memory stick can be connected to store and reload instrument settings and measurement data. Using an adapter cable (R&S NRP-Z4), a power sensor can be connected, as an alternative to the power sensor connector on the rear panel that is only available with Additional Interfaces option, R&S FSL-B5.



Use suitable double shielded cables. Passive USB connecting cables must not exceed 1 m in length.

Use only USB devices that keep the permissible EMI limits.

**GEN OUT 50  $\Omega$** 

The output of the tracking generator is to be connected to the DUT via a cable equipped with a male N connector.

In order to avoid EMI, double shielded cables are recommended.

**NOTICE****Risk of damaging the tracking generator**

A reverse power of 1 W or 50 V DC must never be exceeded in order to avoid damage to the tracking generator.



In the case of DUTs with sensitive RF characteristics with regard to matching (VSWR) at the input, insert a 10 dB attenuator between the DUT and the tracking generator.

## 2.2 Rear Panel

All standard connectors are placed at the bottom of the rear panel. Above all optional connectors are grouped according to their option. The inscriptions on your instrument or in [Figure 2-1](#) match with the captions of the connector descriptions below, if existing.



In order to avoid EMI, double shielded cables are recommended.

**Figure 2-2: Rear panel view**



## 2.2.1 Standard Rear Panel Connectors

### AC power supply connector and AC power switch



The AC power supply connector and the AC power switch are located on the rear panel of the instrument. For an overview on available power supplies refer to chapter 3.

AC power switch function:

- Position **I**: Depending on the setting of the ON/STANDBY function key on the front panel, the instrument is either in standby mode or in operation.
- Position **O**: The entire instrument is disconnected from the AC power supply.

For details on switching on and off refer to chapter 4.



The AC power switch also interrupts the power supply of the OCXO (OCXO Reference Frequency option, R&S FSL-B4). When switching the instrument back on, be sure to comply with the extended warm up phase specified in the data sheet.

**Table 2-1: List of power cables available**

Stock No.	Earthed-contact connector	Preferably used in
DS 006.7013.00	BS1363: 1967' complying with IEC 83: 1975 standard B2	Great Britain
DS 006.7020.00	Type 12 complying with SEV-regulation 1011.1059, standard sheet S 24 507	Switzerland
DS 006.7036.00	Type 498/13 complying with US-regulation UL 498, or with IEC 83	USA/Canada
DS 006.7107.00	Type SAA3 10 A, 250 V, complying with AS C112-1964 Ap.	Australia
DS 0025.2365.00 DS 0099.1456.00	DIN 49 441, 10 A, 250 V, angular DIN 49 441, 10 A, 250 V, straight	Europe (except Switzerland)

## LAN interface



The LAN interface can be used to connect the R&S ETL to a local network for remote control, printouts and data transfer. The assignment of the RJ.45 connector supports twisted pair category 5 UTP/STP cables in a star configuration (UTP stands for "unshielded twisted pair", and STP for "shielded twisted pair").

## EXT TRIG/GATE



The female connector for external trigger/gate input is used to control the measurement by means of an external signal.

The voltage levels are TTL levels (low <math><0.7\text{ V}</math>; high <math>>1.4\text{ V}</math>). The typical input impedance is 10 k $\Omega$ .

In order to avoid EMI, double shielded cables are recommended.

## EXT REF



The setup menu is used to switch between the internal and an external reference. The external reference female connector is used as an input for a 10 MHz reference signal, if **Reference Ext** is selected. The required input level is  $\geq 0$  dBm.

In order to avoid EMI, double shielded cables are recommended.

If the R&S ETL-B4 option is installed, the R&S ETL generates a very precise 10 MHz reference signal with an output level of  $\geq 0$  dBm for other devices. The standard connector EXT REF at the rear panel is used as output, but can also be used as input. Whether it is used as input or output is set via the setup menu: with **Reference Ext** as input, with **Reference Int** as output.



The AC power switch also interrupts the power supply of the OCXO (OCXO Reference Frequency option, R&S FSL-B4). When you switch the instrument back on, be sure to comply with the extended warm-up phase specified in the data sheet.

## ASI OUT



### TV Analyzer/Receiver mode:

Digital TV: MPEG transport stream serial output 75  $\Omega$

In order to avoid EMI, double shielded cables are recommended.

## CCVS OUT



### TV Analyzer/Receiver mode:

- Video source 75  $\Omega$  CCVS 1 V<sub>pp</sub>
  - Analog TV: demodulated video signal  
With the Video Generator option (R&S ETL-K203) installed and the video generator enabled: Video generator output 75  $\Omega$  CCVS 1 V<sub>pp</sub>
  - Digital TV, only with R&S ETL-B281: decoded video signal
- Audio source for radio (FM Stereo / FM Mono, R&S ETL-K110); Provides one of the following demodulated signals: MPX, pilot, RDS/DARC carrier, or digital audio in the AES/EBU format.

In order to avoid EMI, double shielded cables are recommended.

## AUDIO



Audio source 1/L output 600  $\Omega$  balanced

Audio source 2/R output 600  $\Omega$  balanced

In order to avoid EMI, double shielded cables are recommended.

## 2.2.2 DC Power Supply (R&S ETL-B230 Option)



A DC power supply can be connected alternatively to the AC power supply. DC power supplies from +11 V to +18 V and 12 A can be used. The connector is supplied with the accessories.

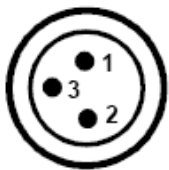

Pin assignment:

- Pin 1 Plus
- Pin 2 Ground
- Pin 3 Not used

### **WARNING**

#### **Danger of shock hazard**

The used power supply (SELV) must fulfill the requirements for reinforced/double insulation for main supply circuits in accordance to DIN/EN/IEC 61010 (UL 61010B.1, CSA C22.2 No. 1010.1) or DIN/EN/IEC 60950 (UL 1950, CSA C22.2 No. 950). It is recommended to fuse the DC power supply according to the table below. Before switching on the instrument check the connection for correct polarity.

### **NOTICE**

#### **Operation in a DC network is not authorized**

According to EN 61326:1997 + A1:1998 + A2:2001 + A3:2003, the DC input is not authorized for operation in a DC network.

The DC cable length must not exceed 30 m.

In continuous operation, the current breaking current can differ from the rated breaking current. For fuse selection take the characteristics of the fuse into account.

**Table 2-2: Fuse selection**

Input voltage	Max. current or power
11 V to 12.5 V	max. 145 VA
12.5 V to 18.7 V	max. 12 A

The instrument is switched on or off using the ON/STANDBY function key on the front panel. For details refer to chapter 4. For an overview on available power supplies refer to section 3.1.

### 2.2.3 GPIB Interface (R&S FSL-B10 Option )



The GPIB interface is in compliance with IEEE488 and SCPI. A computer for remote control can be connected via this interface. To set up the connection, a shielded cable is recommended. For more details refer to the Operating Manual, chapter "Operating Concepts", or the Online Help.

### 2.2.4 EXT REF with OCXO (R&S FSL-B4 Option)



This option generates a very precise 10 MHz reference signal with an output level of  $\geq 0$  dBm for other devices. The standard connector EXT REF at the rear panel is used as output, but can also be used as input. Whether it is used as input or output is set via the setup menu: with **Reference Ext** as input, with **Reference Int** as output.



The AC power switch also interrupts the power supply of the OCXO (OCXO Reference Frequency option, R&S FSL-B4). When you switch the instrument back on, be sure to comply with the extended warm-up phase specified in the data sheet.



## 2.2.5 Bundle Interface Digital (R&S ETL-B201 Option, MOD 02)

The Bundle Interface Digital option, model 02, is fitted in the same space as the Additional Interfaces option (R&S FSL-B5). Therefore only one of these options can be installed.

### SER CLK OUT



Provides the serial clock after demapper. To be used in combination with SER DAT OUT. For the following digital TV standards, this interface is intended for the external BER measurement:

- ATSC/8VSB (R&S ETL-K220)
- DVB-T/H (R&S ETL-K240)
- T-DMB/DAB (R&S ETL-K250)
- ISDB-T (R&S ETL-K260)

### SER DAT OUT



Provides the serial data after demapper. To be used in combination with SER CLK OUT for the same digital TV standards.

### IF OUT 75 Ω



The output signal depends on the selected standard:

- Provides the demodulated video signal if the video generator is enabled:
  - Analog TV, only with R&S ETL-K203
- Provides an IF output signal:
  - DVB-C (R&S ETL-K210): IF = 4.571428 MHz
  - J.83/B (R&S ETL-K213): IF = 4.571428 MHz
  - DTMB (R&S ETL-B211/212/215/216): IF = 5.000000 MHz
- Provides an ETI output signal (only for revision  $\geq$  04.00).
  - DMB-T/DAB (R&S ETL-K250)

**Q IN**

Accepts an analog Q baseband signal. To be used in combination with I IN for all digital TV standards.

You can apply a small frequency offset to the I/Q signal. This offset will be eliminated by the R&S ETL.

The I/Q signal is internally filtered (low pass filter, according to channel settings).

Activate the I/Q input in the AMPT - More menu.

When I/Q input is selected, the spectrum measurement is not available.

**I IN**

Accepts an analog I baseband signal. To be used in combination with Q IN for all digital TV standards.

## 2.2.6 Bundle Interface Digital (R&S ETL-B201 Option, MOD 03)

The Bundle Interface Digital option, model 03, is fitted in the same space as the model 02 and the Additional Interfaces option (R&S FSL-B5). Therefore only one of these options can be installed.

### SER CLK / AF GEN L OUT



The output signal depends on the selected standard:

- Provides the serial clock after demapper. To be used in combination with SER DAT OUT. For the following digital TV standards, this interface is intended for external BER measurement.
  - ATSC/8VSB (R&S ETL-K220)
  - DVB-T/H (R&S ETL-K240)
  - T-DMB/DAB (R&S ETL-K250)
  - ISDB-T (R&S ETL-K260)
- Provides an analog audio generator signal intended to feed the “left signal” (L) or the multiplex (MPX) input of a FM stereo radio transmitter.
  - FM Stereo / FM Mono (R&S ETL-K110/111)

### SER DAT / AF GEN R OUT



The output signal depends on the selected standard:

- Provides the serial data after demapper. To be used in combination with SER CLK OUT for the same digital TV standards.
- Provides an analog audio generator signal intended to feed the “right signal” (R) input of an FM stereo radio transmitter.
  - FM Stereo (R&S ETL-K110/111)

**IF / CCVS / ETI / AF GEN OUT**

The output signal depends on the selected standard:

- Provides the demodulated video signal if the video generator is enabled:
  - Analog TV, only with R&S ETL-K203
- Provides an IF output signal:
  - DVB-C (R&S ETL-K210): IF = 4.571428 MHz
  - J.83/B (R&S ETL-K213): IF = 4.571428 MHz
  - DTMB (R&S ETL-B211/212/215/216): IF = 5.000000 MHz
- Provides an ETI output signal:
  - DMB-T/DAB (R&S ETL-K250)
- Provides an analog audio generator signal intended to feed the multiplex (MPX), the mono (M), or the SCA input of an FM radio transmitter. Alternatively, it provides a digital stereo generator signal in the AES/EBU format.
  - FM Stereo / FM Mono (R&S ETL-K110/111)

**Q / MPX IN**

The input signal depends on the selected standard:

- Accepts an analog Q baseband signal. To be used in combination with I In.
  - All digital TV standards

You can apply a small frequency offset to the I/Q signal. This offset will be eliminated by the R&S ETL.

The I/Q signal is internally filtered (low pass filter, according to channel settings).

Activate the I/Q input in the AMPT - More menu.

When I/Q input is selected, the spectrum measurement is not available.

- Accepts an analog multiplex baseband signal.
  - FM Stereo / FM Mono (R&S ETL-K110/111)

Activate the MPX input in the AMPT - More menu.

When MPX input is selected, the spectrum measurement is not available.

**I / CCVS / IN**

The input signal depends on the selected standard:

- Accepts an analog I baseband signal. To be used in combination with Q IN.
  - All digital TV standards
- Accepts an analog video baseband signal.
  - All analog TV standards

Activate the CCVS input in the AMPT - More menu.

When CCVS input is selected, the spectrum measurement is not available.

## 2.2.7 Additional Interfaces (R&S FSL–B5 Option)

The Additional Interfaces option is fitted in the same space as the Bundle Interface Digital option (R&S ETL-B201). Therefore only one of these options can be installed.

### POWER SENSOR



The LEMOSA female connector is used for connecting power sensors of the R&S NRP–Zxy family. Alternatively, the USB port on the front panel can be used for this purpose, if an adapter cable R&S NRP–Z4 is supplied.

### NOISE SOURCE CONTROL



The noise source control female connector is used to provide the supply voltage for an external noise source, e.g., to measure the noise figure and gain of amplifiers and frequency converting DUTs.

Conventional noise sources require a voltage of +28 V in order to be switched on and 0 V to be switched off. The output supports a maximum load of 100 mA.

An LED indicates the status: green for +28 V, red for overload and off for 0 V.

### IF/VIDEO OUT



The female BNC connector is used as an intermediate frequency (IF) output of approximately 20 MHz or as video output at the set video and resolution bandwidth. The setup menu (SETUP key) is used to select between the IF and video output.



This connector cannot be used simultaneously with the AF output connector on the front panel.

**AUX PORT**

The 9 pole SUB-D male connector provides control signals for controlling external devices. The voltage levels are of the TTL type (max. 5 V).

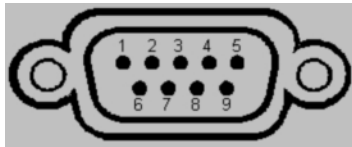

**Table 2-3: Pin assignment**

Pin	Signal	Description
1	+5 V / max. 250 mA	Supply voltage for external circuits
2 to 7	I/O	Reserved for future use
8	GND	Ground
9	READY FOR TRIGGER	Signal indicating that the instrument is ready to receive trigger signal (low active = 0 V).

**NOTICE****Risk of damaging the instrument**

A short-circuit may damage the instrument. Watch the pin assignment carefully.

## 2.2.8 MPEG Processing Board (R&S ETL–B280 Option)

The MPEG Processing Board option (R&S ETL–B280) is fitted in the same space as the Battery Pack option (R&S ETL–B235). Therefore only one of these options can be installed.

The MPEG Processing Board option extends the functionality of the R&S ETL to analyze (R&S ETL-K282) and generate (R&S ETL-K280) MPEG-2 Transport Streams. Additionally, the MPEG Processing Board option can include the R&S ETL–B281 (Video/ Audio Hardware Decoder) option. An R&S ETL also fitted with this option provides functionality to decode TV programs (SDTV and HDTV) within an MPEG-2 Transport Stream.

### DVB COMMON INTERFACE



Ready for future applications. The pin assignment is conform to the European standard EN50221.

### TS ASI IN



The female BNC connector is used as ASI (Asynchronous Serial Interface) conform to EN50083-9.

For the MPEG analysis (MPEG-TS Analyzer/Monitoring option, R&S ETL–K282), the external MPEG-2 Transport Stream is input at this connector.

### TS ASI OUT



The female BNC connector is used as ASI (Asynchronous Serial Interface) conform to EN50083-9.

The MPEG-2 Transport Stream (output signal) is generated by the MPEG-TS Generator / Recorder option (R&S ETL–K280).



## HDMI OUT



The 19pin, female HDMI (High-Definition Multimedia Interface) is the interface for digital video and audio output. The pin assignment is conform to the HDMI 1.1 standard.

The output signal is generated by the Video/ Audio Hardware Decoder option (R&S ETL–B281).

### 2.2.9 Battery Pack (R&S ETL–B235 Option)

The Battery Pack option (R&S ETL–B235) is fitted in the same space as the MPEG Processing Board option (R&S ETL–B280). Therefore only one of these options can be installed.

The Battery Pack can be used alternatively as power supply. The Battery Pack is described in a separate manual (2112.1069.32) provided with the option. For further information refer to this manual.

---

#### **⚠ WARNING**

##### **Risk of physical injury**

To avoid physical injury to yourself or others, always follow the instructions provided in the Battery Pack manual. Furthermore, observe the general safety instructions at the beginning of this manual.

---



## 3 Connecting the Instrument

This chapter describes the power supply options and how to connect the instrument to the power supply and external devices.

### 3.1 Connecting to the Power Supply

By standard, the R&S ETL uses an AC power supply. In order to use the R&S ETL independently from an AC power supply, the R&S ETL can be additionally fitted with a DC power supply (DC Power Supply option, R&S ETL-B230) and/or a battery pack (Battery Pack option, R&S ETL-B235). For details on the different power supplies refer to chapter 2.

From the available power supplies, the R&S ETL selects the one to use according to the following priority scheme:

Priority	Power supply
1	AC power supply
2	DC power supply
3	battery pack

For example, if the R&S ETL is connected to both an AC and a DC power supply, it uses the AC power supply. If it is suddenly disconnected from the AC power supply, it switches to the DC power supply.

#### 3.1.1 Connecting to the AC Power Supply

The R&S ETL can be used with different AC power voltages and adapts itself automatically to it. Refer to the datasheet for the requirements of voltage and frequency. The AC power connector is located on the rear panel of the instrument.

*Figure 3-1: AC power connector*



- ▶ Connect the R&S ETL to the AC power supply, using the power cable that is supplied.

Since the instrument is assembled in line with the specifications for safety class EN61010, it may only be connected to an outlet that has a ground contact.

## 3.2 Connecting External Devices

The two USB interfaces on the front panel of the R&S ETL allow you to connect USB devices directly to the analyzer. This number can be increased as necessary by using USB hubs.

Due to the large number of available USB devices, there is almost no limit to the expansions that are possible with the R&S ETL. The following list shows various USB devices that can be useful for the R&S ETL:

- Power sensors of the R&S NRP Zxy family
- Memory stick for easy transfer of data to/from a computer (e.g. firmware updates)
- CD-ROM drives for easy installation of firmware applications
- Keyboard for entering comments, file names, etc
- Mouse for easy operation of Windows dialog boxes
- Printer for printing out measurement results

Installing USB devices is easy under Windows XP, because all USB devices are plug&play. All USB devices can be connected to or disconnected from the R&S ETL during operation.

After a device is connected to the USB interface of the R&S ETL, Windows XP automatically searches for a suitable device driver.

If Windows XP does not find a suitable driver, it will prompt you to specify a directory that contains the driver software. If the driver software is on a CD-ROM, connect a USB CD-ROM drive to the R&S ETL before proceeding.

When a USB device is subsequently disconnected from the R&S ETL, Windows XP immediately detects the change in hardware configuration and deactivates the corresponding driver.

### **Example: To connect a memory stick to the R&S ETL**

1. Connect the memory stick to the USB interface.

Windows XP detects the new hardware and installs the corresponding driver. If installation is successful, Windows XP informs you that the device is ready to use.

The memory stick is made available as a new drive (D:) and is displayed under Windows Explorer. The name of the memory stick is manufacturer-dependent (in this example it is called "Removable Disk"). The memory stick can be used like a normal drive to load or store data.



If the Internal Hard Disk Drive option (R&S ETL-B209) is installed, the memory stick is mapped to the E: drive.

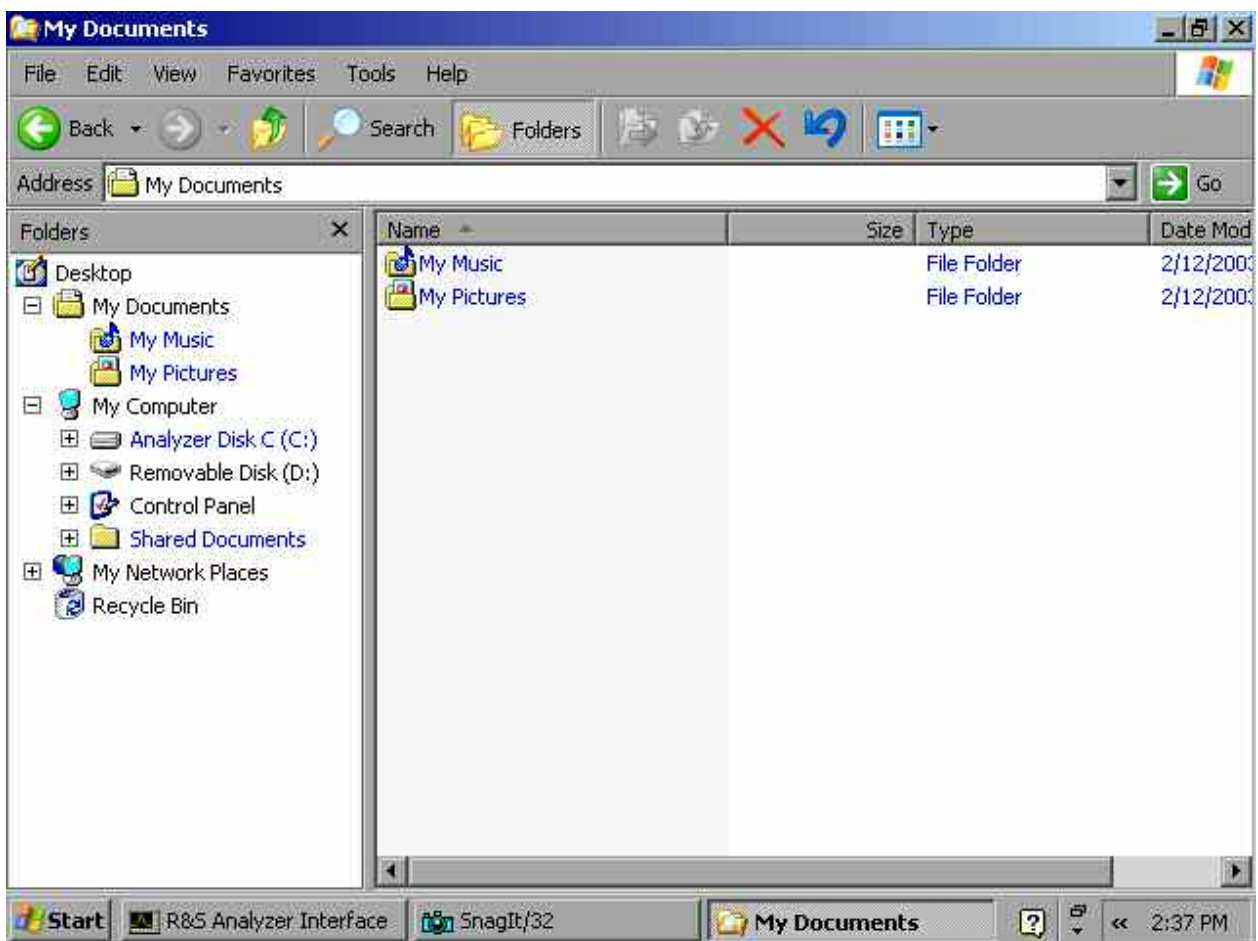

2. If you no longer need the memory stick or if you want to transfer files to another computer, simply disconnect the memory stick.

Windows XP automatically deactivates the driver. If the drive is still selected in Explorer, an error message will appear indicating that the drive is no longer available.



## 4 Switching On or Off the Instrument

### **⚠ CAUTION**

#### **Risk of injuries**

Prior to switching on the instrument, make sure that the following conditions are fulfilled:

- The instrument cover is in place and tightly screwed on.
- Fan openings are not obstructed.
- Signal levels at the inputs are within specified limits.
- Signal outputs are connected correctly and not overloaded.

Any non-compliance may endanger people and may cause damage to the instrument.

For an overview on available power supplies refer to section [3.1](#).

### 4.1 Instrument Modes

Three different instrument modes exist:

#### **On mode**

The instrument is supplied with power by one of the available power supplies (see also section [3.1](#)). After booting, the instrument is ready for operation. A green LED above the ON/STANDBY key indicates this mode.

#### **Standby mode**

This mode is only available if the instrument is connected to the AC power supply (AC power switch in position I; for details refer to chapter [2](#)). A yellow LED above the ON/STANDBY key indicates this mode. Parts of the instrument are still active, e.g. the oven of the OCXO unit (OCXO Reference Frequency option, R&S FSL-B4) is kept active. To prevent the instrument from overheating the fan remains active.

When switched on in this mode, the R&S ETL will rapidly resume operation. It preserves the current settings and when switched back on, the last measurement is displayed.

### Off mode

The instrument is switched off completely. Both LEDs are off. When switched on again, the instrument starts booting. If the OCXO unit (OCXO Reference Frequency option, R&S FSL–B4) is used, an extended warm-up phase as specified in the data sheet is required.

## 4.2 Switching On the Instrument

- ▶ AC power supply: Press the AC power switch on the rear panel into position I.
- ▶ DC power supply/battery pack or standby mode: Press the ON/STANDBY key on the front panel.

## 4.3 Switching Off the Instrument

Depending on the used power supply, the instrument changes to different modes when pressing the ON/STANDBY key on the front panel or switching off the AC power at the rear panel. An overview is given in section [4.4](#).



Do not press the ON/STANDBY key longer than 3 seconds.

### 4.3.1 Switching into Standby Mode

Prerequisites:

- The instrument is in operation.
- The instrument is connected to the AC power supply.
- The AC power switch on the rear panel is in position I.
- The shutdown behavior is configured accordingly (**SETUP** key; for details refer to the Operating Manual or the Online Help).



- ▶ Press the ON/STANDBY key on the front panel.

The R&S ETL will store the current settings on the hard disk and switch to standby mode (for details on the standby mode refer to section 4.1).

---

**⚠ WARNING****Danger of shock hazard**

In standby mode, there is still AC supply voltage present in the instrument.

---

### 4.3.2 Switching into Off Mode

**DC power supply/battery pack:**

- ▶ Press the ON/STANDBY key on the front panel.  
The R&S ETL changes into off mode.

**AC power supply:**

Prerequisite: The shutdown behavior is configured accordingly (**SETUP** key; for details refer to the Operating Manual or the Online Help).

1. Press the ON/STANDBY key on the front panel.
2. Change the AC power switch on the rear panel to position O, or disconnect the instrument from the AC power supply.

The R&S ETL changes into off mode, if no alternative power supply is available.



The R&S ETL will preserve its current instrument settings if switched off via the ON/STANDBY key. It will lose its settings if switched off at the rear panel or if the power cord is disconnected without pressing the ON/STANDBY key first. In this case, the last settings that were stored on the hard disk will be loaded when you switch the instrument back on.

The AC power switch also interrupts the power supply of the OCXO (OCXO Reference Frequency option, R&S FSL-B4). When you switch the instrument back on, be sure to comply with the extended warm-up phase specified in the data sheet.

---

## 4.4 Behavior of the ON/STANDBY Key

Depending on the used power supply, the ON/STANDBY key on the front panel leads to different modes (see also section 4.1). For details on the power supply options refer to section 3.1.

Power supply	Instrument mode	Action	Instrument reaction
AC	on	Press the ON/STANDBY key.	Changes into standby or off mode, depending on the status of the <b>Shutdown Off/Standby</b> softkey ( <b>SETUP</b> key, for details refer to the Operating Manual or the Online Help)
	on	Disconnect instrument from AC power supply or switching AC power switch in position 0 (not recommended).	Changes into off mode without saving the current settings
	standby	Press the ON/STANDBY key.	Changes into on mode
	standby	Disconnect instrument from AC power supply or switching AC power switch in position 0.	Changes into off mode
	off	Connect instrument to AC power supply and/or switching AC power switch at the rear panel in position I.	Starts booting
DC	on	Press the ON/STANDBY key.	Changes into off mode
	off	Press the ON/STANDBY key.	Starts booting
	on/off	Switch the AC power switch at the rear panel in position I.	No action
battery	on	pressing the ON/STANDBY key	changes into off mode
	off	pressing the ON/STANDBY key	starts booting
	on/off	switching the AC power switch at the rear panel in position I	no action

When switched on from standby mode, the R&S ETL will directly display the measurement screen and resume operation after a few moments. Otherwise, after being switched on, the R&S ETL starts booting. It displays the Analyzer BIOS screen and performs a self test of the computer hardware. The firmware starts as soon as Windows XP has resumed operation.

## 4.5 Checking the Provided Options

The instrument may be equipped with both hardware and firmware options. In order to check whether the installed options correspond to the options indicated on the delivery note, proceed as follows.

1. Press the **SETUP** key.
2. Press the **More** ↓ key.
3. Press the **System Info** softkey.
4. Press the **Versions + Options** softkey.

A list with hardware and firmware information is displayed.

5. Check the availability of the hardware options: as indicated in the delivery note.
6. Check the options enabled via license keys as indicated in the delivery note.

For an overview of the all options available for the instrument refer to the Rohde & Schwarz Homepage.

## 4.6 Turn-On Tests



These functional tests should only be performed when the operating temperature is reached (approx. 15 minutes after the instrument is switched on, refer to the data sheet for details).

### 4.6.1 Performing a Self Alignment

1. Press the **SETUP** key.
2. Press the **Alignment** softkey
3. Press the **Self Alignment** softkey.

Once the system correction values have been calculated successfully, a message will be displayed.

## 4.6.2 Performing a Self Test

1. Press the **SETUP** key.
2. Press the **More** ↓ key.
3. Press the **Service** softkey.
4. Press the **Selftest** softkey.

Once the instrument modules have been checked successfully, a message will be displayed.

Once both steps have been completed successfully, the instrument will be ready for operation.



The self test does not need to be repeated every time the instrument is switched on. It is only necessary when instrument malfunction is suspected.

---

## 5 Sample Application

Follow the instructions in this chapter to perform your first measurement with the R&S ETL. For an expanded selection of measurement examples and background information refer to the Operating Manual or the Online Help.

The chosen example applies to the DVB-C and J.83/A/C TV standard. It gives an overview of the active measurement channel. All parameters are set according to the modulation standard, referenced in the channel table or by the default digital TV modulation standard. The spectrum is displayed in a full screen trace.

### 5.1 Test Setup

Use a digital TV generator as signal source (e.g. R&S SFU). Connect the generator directly to the R&S ETL. Set the TV generator to the following parameters:

- center frequency = 100 MHz
- single carrier 64QAM modulation.
- root raised cosine transmit filter with a roll-off factor of 0.15.
- symbol rate = 6.9 MSymbols/s.

### 5.2 Setting the TV Analyzer/Receiver Mode

After preset, the R&S ETL is in the **Spectrum Analyzer** mode. To perform TV measurements, change into the **TV Analyzer/Receiver** mode:

- ▶ Press the **MODE** key and activate the **TV Analyzer/Receiver** option.

For further information on measurement modes, refer to the Operating Manual, chapter "Operating Concepts", or the Online Help.

### 5.3 Performing the Measurement

1. Press the **FREQ** key and enter *100 MHz* for the center frequency.
  2. Press the **MENU** key.
  3. Press the **Digital TV** softkey.
  4. Press the **MEAS** key and then the **Digital TV Settings** softkey:
    - Compare the modulation parameters.
    - Select the correct modulation standard.
  5. Press the **Spectrum** softkey.
  6. To adjust the input attenuator, press the **Adjust Attenuation** softkey.
- The spectrum of the input signal is displayed.

Figure 5-1: Digital TV Spectrum measurement

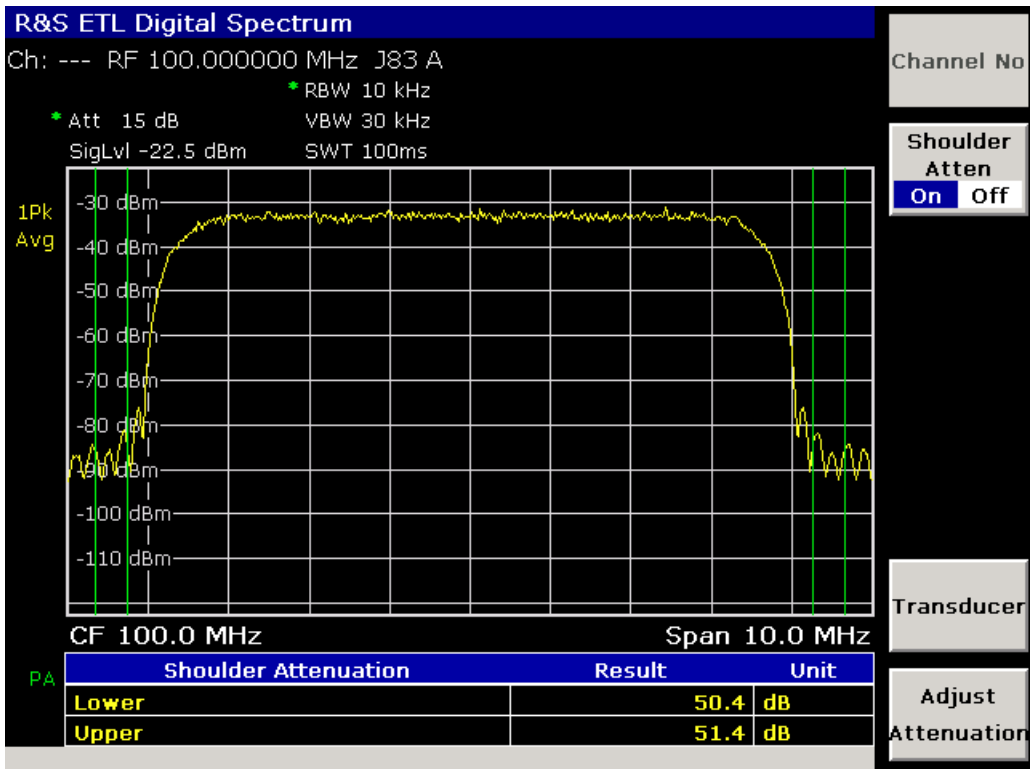

## 6 Operating the Instrument in a LAN

This chapter describes how to configure the LAN interface. For further information on the LAN interface refer to the Operating Manual, chapter "Instrument Setup and Interface Configuration", or the Online Help.

The instrument can be connected to an Ethernet LAN (local area network) using the LAN interface connector on the rear panel (for details refer to chapter 2). This makes it possible to transfer data over the network and to use network printers. In addition, the instrument can be remote-controlled via the network. The network card can be operated with a 10 MHz Ethernet IEEE 802.3 or a 100 MHz Ethernet IEEE 802.3u interface.

### 6.1 Connecting the Instrument to the Network

#### **NOTICE**

Before connecting the instrument to the network, consult your network administrator, particularly in the case of large LAN installations. Connection errors may affect the entire network.

Never connect your instrument to a network unprotected against virus infection because this may cause damage to the instrument software.

Setting up the connection does not cause any problems on the network. Likewise, disconnecting the instrument from the network does not cause any problems as long as no data traffic to and from the instrument is in progress.

### 6.2 Configuring the Network Card

Under Windows XP, network card drivers do not need to be installed separately. If the instrument is connected to the LAN, Windows XP automatically detects the network connection and activates the required drivers.

## 6.2.1 Changing the IP Address and Configuring the Network Protocols (TCP/IP Protocol)

Before starting, check the following:

- Which IP addresses and subnet masks are suitable for your network? If necessary, ask your network administrator.
- Has your network a DHCP server? If necessary, ask your network administrator.

If your network has a DHCP server, the IP address is to be requested from a DHCP server automatically. For the further proceeding refer to section [6.2.1.3](#).

If your network has no DHCP server, refer to section [6.2.1.2](#).

### 6.2.1.1 To Display the Network Address Submenu

1. Press the **SETUP** key.
2. Press the **General Setup** softkey.
3. Press the **Network Address** softkey.

The submenu is displayed.

### 6.2.1.2 To Configure the Network Protocol in a Network without DHCP Server

1. In the network address submenu, set the **DHCP On/Off** softkey to **Off**. If the status is changed from **On** to **Off**, the previous set IP address and subnet mask are retrieved.
2. Press the **IP Address** softkey and enter the IP address, for example *10.0.0.10*. The IP address consists of four number blocks separated by dots. Every block contains 3 numbers in maximum.
3. Press the **Subnet Mask** softkey and enter the subnet mask, for example *255.255.255.0*. The subnet mask consists of four number blocks separated by dots. Every block contains 3 numbers in maximum.
4. If you have entered an invalid IP address or subnet mask, in the status line, the message "out of range" is displayed. The edit dialog box keeps open, and you can start afresh.
5. If the settings are correct, the configuration is saved, and you are prompted to restart the instrument.
6. Confirm the displayed message (**Yes** button) to restart the instrument.



### 6.2.1.3 To Configure the Network Protocol in a Network with DHCP Server

1. In the network address submenu, set the **DHCP On/Off** softkey to **On**.

The IP address of the DHCP server is obtained automatically. The configuration is saved, and you are prompted to restart the instrument.

2. Confirm the displayed message (**Yes** button) to restart the instrument.



# 7 Installed Software

The firmware and the operating system are already installed on the instrument.

## Further information

- Performing a firmware update: see the Release Notes.
- Installing software options: see the Operating Manual, chapter "Firmware Update".

## 7.1 Operating System

The instrument contains the Windows XP Embedded operating system. To ensure that the instrument software functions properly, certain rules must be adhered to when using the operating system.

---

### **NOTICE**

#### **Possible impairment of the instrument functioning**

The instrument is equipped with the Windows XP operating system. It is thus possible to install software on the instrument. The use and installation of additional software may impair the instrument function. For this reason, we recommend that you only execute programs tested by Rohde & Schwarz with regard to their compatibility with the instrument software. The tested program packages are listed in section [7.2](#).

In certain cases, the use of these programs can impair the performance of the instrument.

The drivers and programs used on the instrument under Windows XP have been adapted to the instrument. Existing instrument software must only be modified with update software released by Rohde & Schwarz.

---

## 7.1.1 Windows XP Start Menu

The Windows XP Start menu provides access to the Windows XP functionality and installed programs. From the start menu, you can navigate to the submenus by using the mouse or the cursor keys of the keyboard.



The following operations require an external keyboard.

---

### 7.1.1.1 To Open the Windows XP Start Menu

1. Press the **FILE** key.
2. Press the **More**  key.
3. Press the **Desktop** softkey.
4. Set the focus on the **Start** button in the task bar using the tab and arrow keys.
5. Press the **ENTER** key.

If an external keyboard is connected (alternative):

- ▶ Press the Windows key or the **CTRL+ESC** key combination.

### 7.1.1.2 To Return to the Measurement Screen

- ▶ Press any hardkey.

If an external keyboard is connected (alternative):

- ▶ Press the **ALT+TAB** key combination to switch to the analyzer application.
- ▶ On the task bar, click the **R&S Analyzer Interface** button.

## 7.1.2 Windows XP Service Packs

The Windows XP Embedded operating system on the instrument is supplied with pre-installed XP Embedded service packs that are necessary and suitable for operating the instrument.

### NOTICE

#### Risk of instrument damage

To prevent malfunctions that might in the worst case require instrument repair, only service packs approved by Rohde & Schwarz may be installed on the instrument.

You should be particularly careful not to use service packs from Windows XP Home Edition or Professional Edition because they are not compatible with Windows XP Embedded.

## 7.1.3 Login

Windows XP requires that users identify themselves by entering a user name and password in a login window. The instrument provides a factory-installed auto login function, i.e. login is carried out automatically in the background. The ID used for auto login has administrator rights. As user name "instrument" is set, as password "instrument" or "894129" is set.

At the same time you log on to the operating system, you are automatically logged on to the network. As a prerequisite, the user name and the password must be identical under Windows XP and on the network.

### 7.1.3.1 To Deactivate the Automatic Login Mechanism

When shipped, the instrument is already configured to automatically log on under Windows XP.

1. In the **Start** menu, select **Run**.

The **Run** dialog box is displayed.

2. Enter the `C:\R_S\INSTR\USER\NOAUTOLOGIN.REG` command.

3. Press the **ENTER** key to confirm.

The automatic login mechanism will be deactivated. The next time you switch on the instrument, you will be prompted to enter your user name and password before the firmware is started.

### 7.1.3.2 To Reactivate the Automatic Login mechanism

1. In the **Start** menu, select **Run**.

The **Run** dialog box is displayed.

2. Enter the `C:\R_S\INSTR\USER\AUTOLOGIN.REG` command.
3. Press the **ENTER** key to confirm.

The automatic login mechanism will be reactivated. It will be applied the next time the instrument is switched on.

## 7.2 Additional Software

The driver software that is used and the system settings of Windows XP have been fine-tuned to support the measurement functions of the R&S ETL. Thus, for flawless instrument function software and hardware approved or offered by Rohde & Schwarz must be used.

Using other software or hardware may cause the functions of the R&S ETL to perform improperly or fail. The following program packages have been successfully tested for compatibility with the measurement instrument software:

- R&S Power Viewer (virtual power meter for displaying results of the R&S NRP power sensors)
- Windows XP Remote Desktop
- FileShredder – For reliable deletion of files on the hard disk
- R&S ETL TxCheck
- R&S ETL Transposer Check

## 8 Maintenance

The instrument does not need a periodic maintenance. What is necessary is essentially the cleaning of the instrument. However, it is recommended to check the rated data from time to time.

The address of our support center and a list of all Rohde & Schwarz service centers can be found at the beginning of this manual.

### 8.1 Cleaning the Instrument

The outside of the instrument is suitably cleaned using a soft, line-free dust cloth. Make sure that vents are not obstructed.

---

**⚠ WARNING****Danger of shock hazard**

Before cleaning the instrument, ensure that the instrument is switched off and disconnected from all power supplies.

---

---

**NOTICE****Instrument damage caused by cleaning agents**

Cleaning agents contain substances that may damage the instrument, e.g. solvent-containing cleaning agents may damage the front panel labeling or plastic parts.

Never use cleaning agents such as solvents (thinners, acetone, etc), acids, bases, or other substances.

---

## 8.2 Replacing the Fuses

The instrument is protected by two fuses (IEC 127 – T 3.15 H / 250 V) located on the rear panel at the right side of the AC power switch.

### **WARNING**

#### **Danger of shock hazard**

For fuse replacement, ensure that the instrument is switched off and disconnected from the power supply by removing the plug from the AC and DC power connector.

1. Open the lid of the AC power connector.
2. Lift the fuse holder out of its slot.
3. Exchange the two fuses.
4. Put the fuse holder back in its slot and close the lid.

## 8.3 Storing the Instrument

The storage temperature range of the instrument is given in the data sheet. If the instrument is to be stored for a longer period of time, it must be protected against dust.

Repack the instrument as it was originally packed when transporting or shipping. The two protective foam plastic parts prevent the control elements and connectors from being damaged. The antistatic packing foil avoids any undesired electrostatic charging to occur.

If you do not use the original packaging, provide for sufficient padding to prevent the instrument from slipping inside the package. Wrap antistatic packing foil around the instrument to protect it from electrostatic charging.



# Index

AC power connector .....	26	Q IN .....	32, 35
AC power supply		RF IN .....	22
connecting to .....	41	SER CLK / AF GEN L OUT .....	33
administrator ID .....	59	SER CLK OUT .....	31
AF OUT connector .....	23	SER DAT / AF GEN R OUT .....	33
aligning .....	49	SER DAT OUT .....	31
AMPT key .....	15	TS ASI IN .....	38
arrow keys .....	20	TS ASI OUT .....	38
ASI OUT connector .....	28	USB .....	23
AUDIO connector .....	28	conventions .....	8
automatic login		DC power connector .....	29
deactivate .....	59	DC power supply connector .....	30
reactivate .....	60	DHCP server .....	54
AUX PORT connector .....	37	documentation overview .....	7
BACK key .....	18	DVB COMMON INTERFACE connector .....	38
bench operation .....	11	ENTER key .....	18
BW key .....	15	ESC/CANCEL key .....	18
recommended calibration interval .....	11	EXT REF connector .....	27
CCVS OUT connector .....	28	EXT TRIG/GATE connector .....	27
checking provided option .....	49	external devices .....	42
checking the accessories .....	10	connecting .....	42
CHECKMARK key .....	21	connecting (example memory stick) .....	42
cleaning the outside .....	61	FIELD keys .....	20
connector		FILE key .....	14
AC power .....	26	firmware options .....	49
AF OUT .....	23	First Steps manual .....	7
ASI OUT .....	28	FREQ key .....	15
AUDIO .....	28	front panel .....	13
AUX PORT .....	37	functional test .....	49
CCVS OUT .....	28	fuses	
DC power .....	29	replacing .....	62
DC power supply .....	30	GEN OUT connector .....	24
DVB COMMON INTERFACE .....	38	GPIB connector .....	30
EXT REF .....	27	hardware options .....	49
EXT TRIG/GATE .....	27	HDMI OUT connector .....	39
GEN OUT .....	24	HELP key .....	15
GPIB .....	30	I / CCVS / IN connector .....	35
HDMI OUT .....	39	I IN connector .....	32, 35
I / CCVS / IN .....	35	IF / CCVS / ETI / AF GEN OUT connector .....	34
I IN .....	32, 35	IF OUT connector .....	31
IF / CCVS / ETI / AF GEN OUT .....	34	IF/VIDEO OUT connector .....	36
IF OUT .....	31	instrument modes .....	45
IF/VIDEO OUT .....	36	IP address .....	54
LAN .....	27	key	
NOISE SOURCE CONTROL .....	36	AMPT .....	15
POWER SENSOR .....	36	BACK .....	18
Q / MPX IN .....	35	BW .....	15

CHECKMARK .....	21	standby .....	45
DN ARROW .....	20	TV Analyzer .....	51
ENTER .....	18	MODE key .....	15
ESC/CANCEL .....	18	network	
FIELD LEFT .....	20	automatic logon .....	59
FIELD RIGHT .....	20	configuring card .....	53
FILE .....	14	connecting to .....	53
FREQ .....	15	NEXT TAB key .....	21
HELP .....	15	NOISE SOURCE CONTROL connector .....	36
LEFT ARROW .....	20	OCXO .....	30
LINES .....	17	off mode .....	46
MEAS .....	17	on mode .....	45
MENU .....	15	ON/STANDBY key .....	14, 48
MKR .....	16	Online Help .....	7, 15
MKR-> .....	16	Operating Manual .....	7
MODE .....	15	operating system	
NEXT TAB .....	21	Windows XP .....	57
ON/STANDBY .....	14, 48	options	
PRESET .....	14	checking .....	49
PRINT .....	14	firmware .....	49
RIGHT ARROW .....	20	hardware .....	49
RUN .....	16	packing .....	62
SETUP .....	14	password	
SPAN .....	15	Windows XP .....	59
SWEEP .....	15	POWER SENSOR connector .....	36
TRACE .....	17	power supply .....	41
TRIG .....	16	connecting to .....	41
UP ARROW .....	20	connector (DC) .....	30
keypad .....	17	PRESET key .....	14
LAN connector .....	27	PRINT key .....	14
LINES key .....	17	provided options	
login		checking .....	49
automatic .....	59, 60	Q / MPX IN connector .....	35
Windows XP .....	59	Q IN connector .....	32, 35
maintenance .....	61	rack mounting .....	12
manual		replacing fuses .....	62
First Steps .....	7	RF IN connector .....	22
Operating Manual .....	7	rotary knob .....	19
MEAS key .....	17	RUN key .....	16
measurement		self alignment .....	49
test setup .....	51	self test .....	50
measurement example .....	51	SER CLK / AF GEN L OUT connector .....	33
measurement mode .....	51	SER CLK OUT connector .....	31
memory stick		SER DAT / AF GEN R OUT connector .....	33
connecting .....	42	SER DAT OUT connector .....	31
MENU key .....	15	service pack .....	59
MKR key .....	16	SETUP key .....	14
MKR-> key .....	16	ship damage inspection .....	10
mode		software	
off .....	46	additional .....	60
on .....	45	Software Manual	

WiMAX IEEE 802.16 OFDM/OFDMA	
Application Firmware option (R&S FSL-	
K93) .....	7
SPAN key .....	15
standby mode .....	45
Start menu .....	58
storing .....	62
subnet mask .....	54
SWEEP key .....	15
switching into standby mode .....	47
switching off the instrument .....	47
switching on the instrument .....	46
test setup .....	51
TRACE key .....	17
TRIG key .....	16
TS ASI IN connector .....	38
TS ASI OUT connector .....	38
unpacking the instrument .....	9
USB connector .....	23
external devices .....	42
warranty .....	11
Windows XP .....	57
additional software .....	60
administrator ID .....	59
login .....	59
password .....	59
service packs .....	59
Start menu .....	58